

LEGO

SPORTS

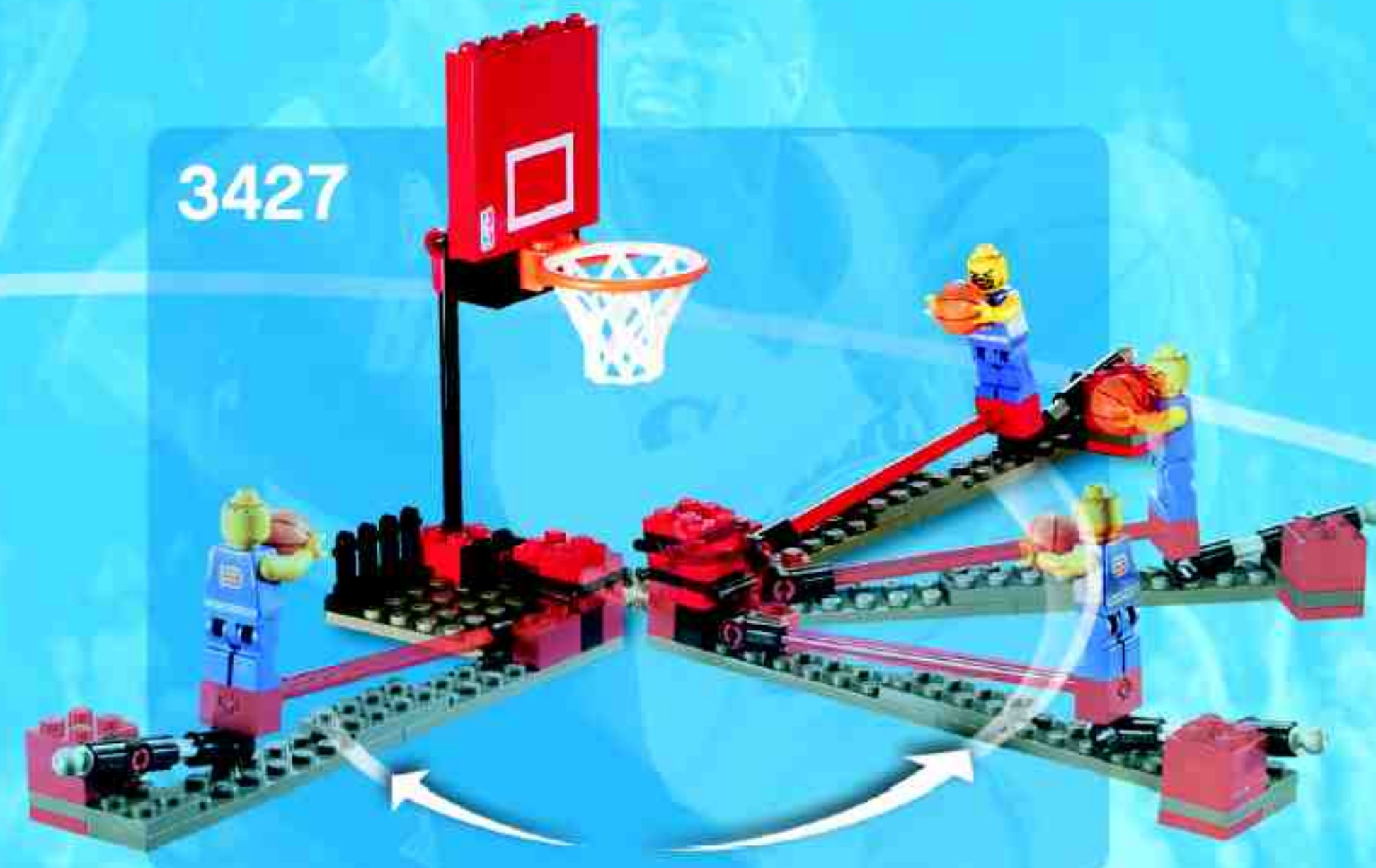

NBA





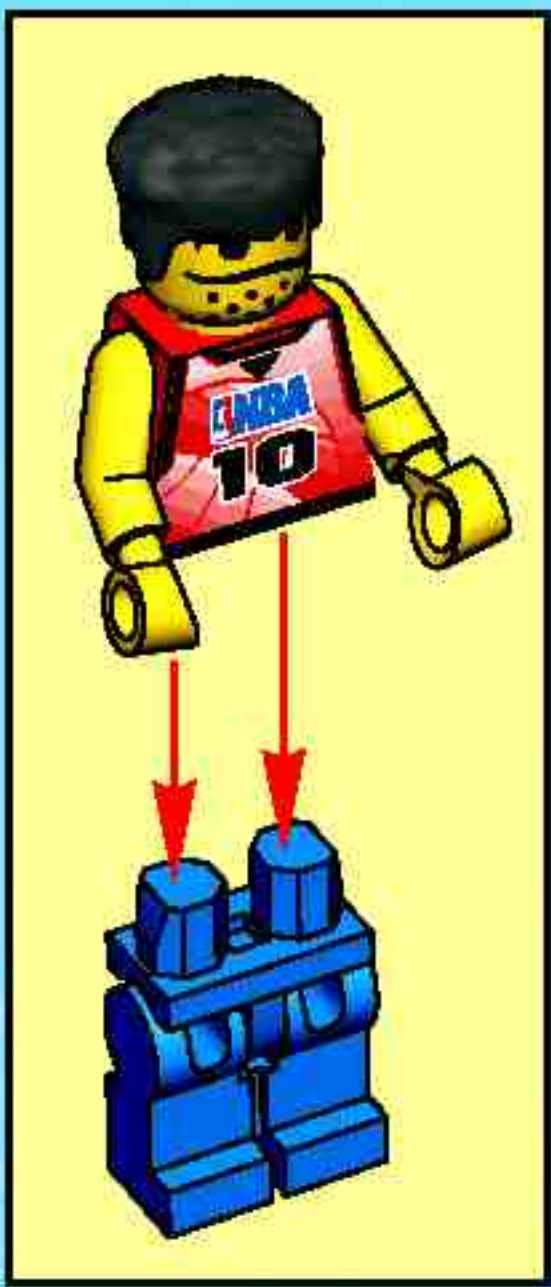

1

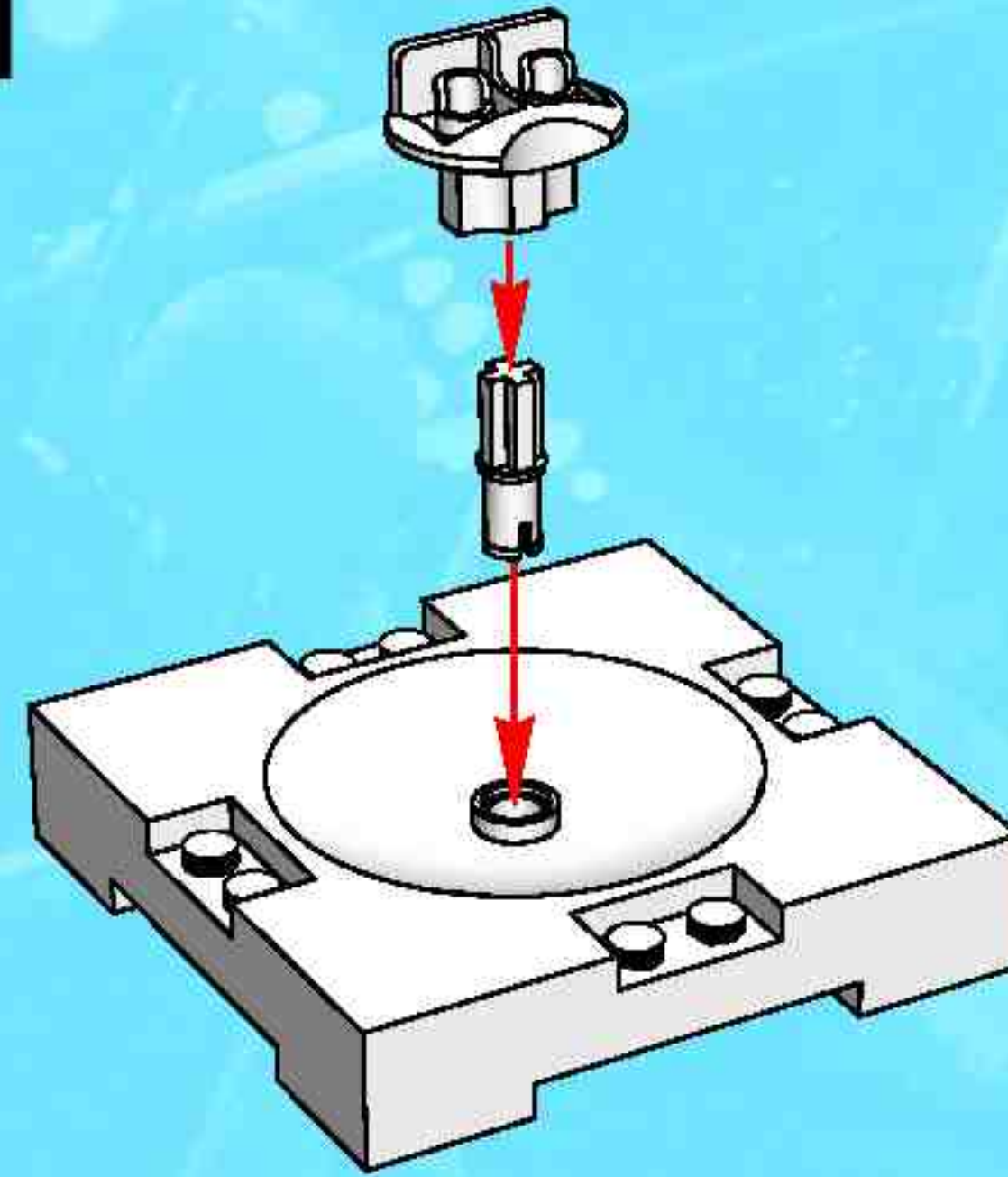

2

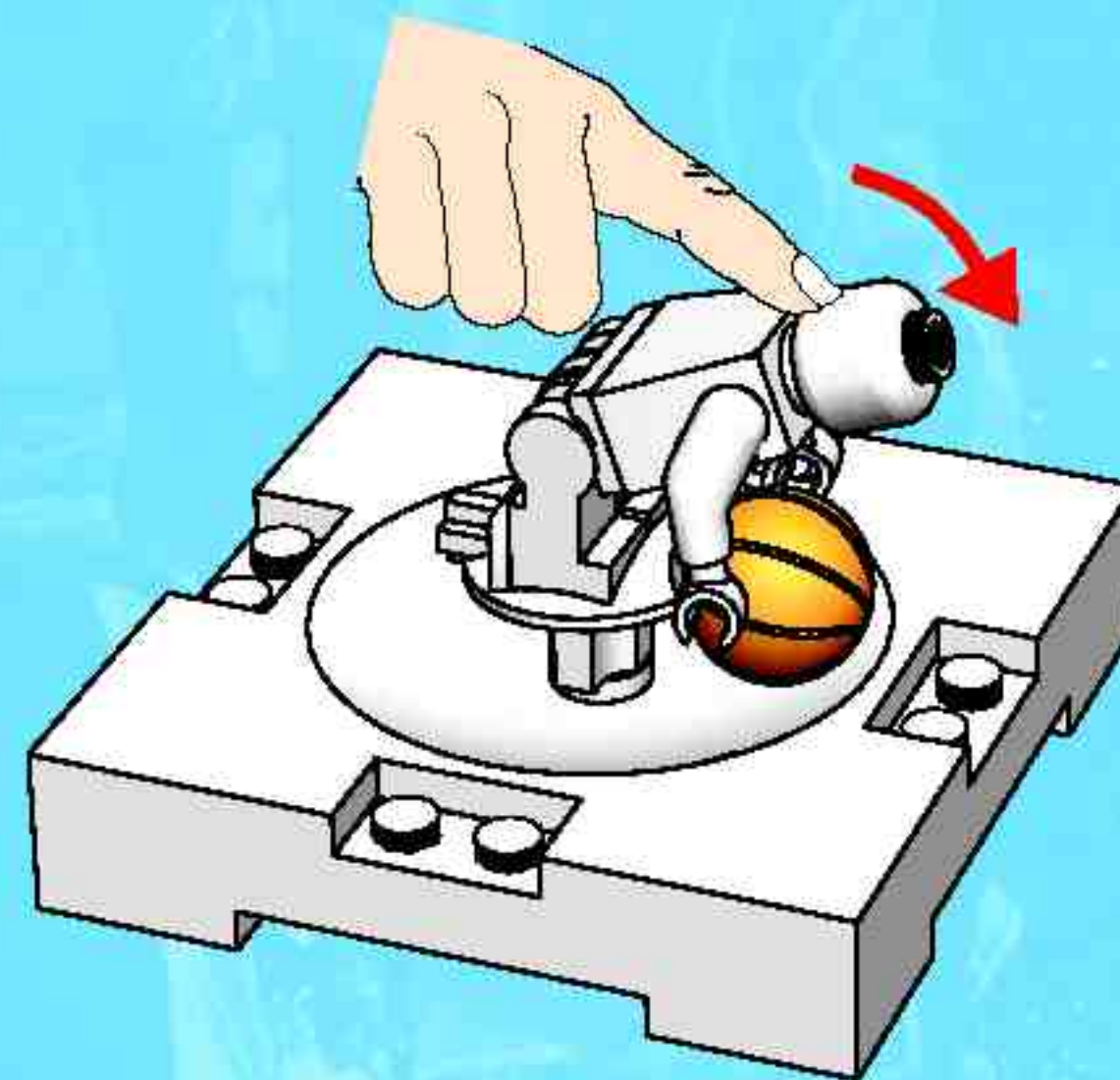

3

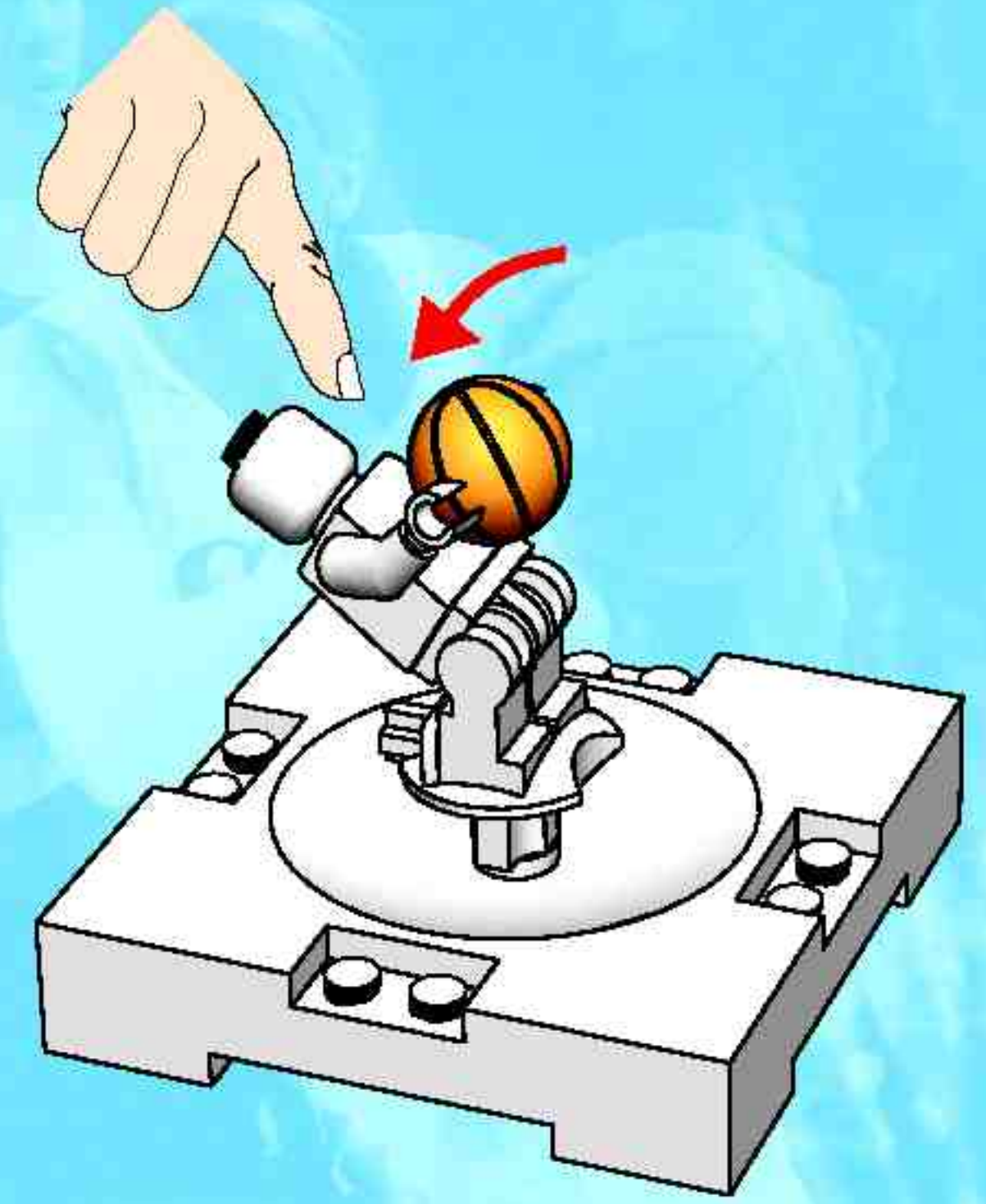

4

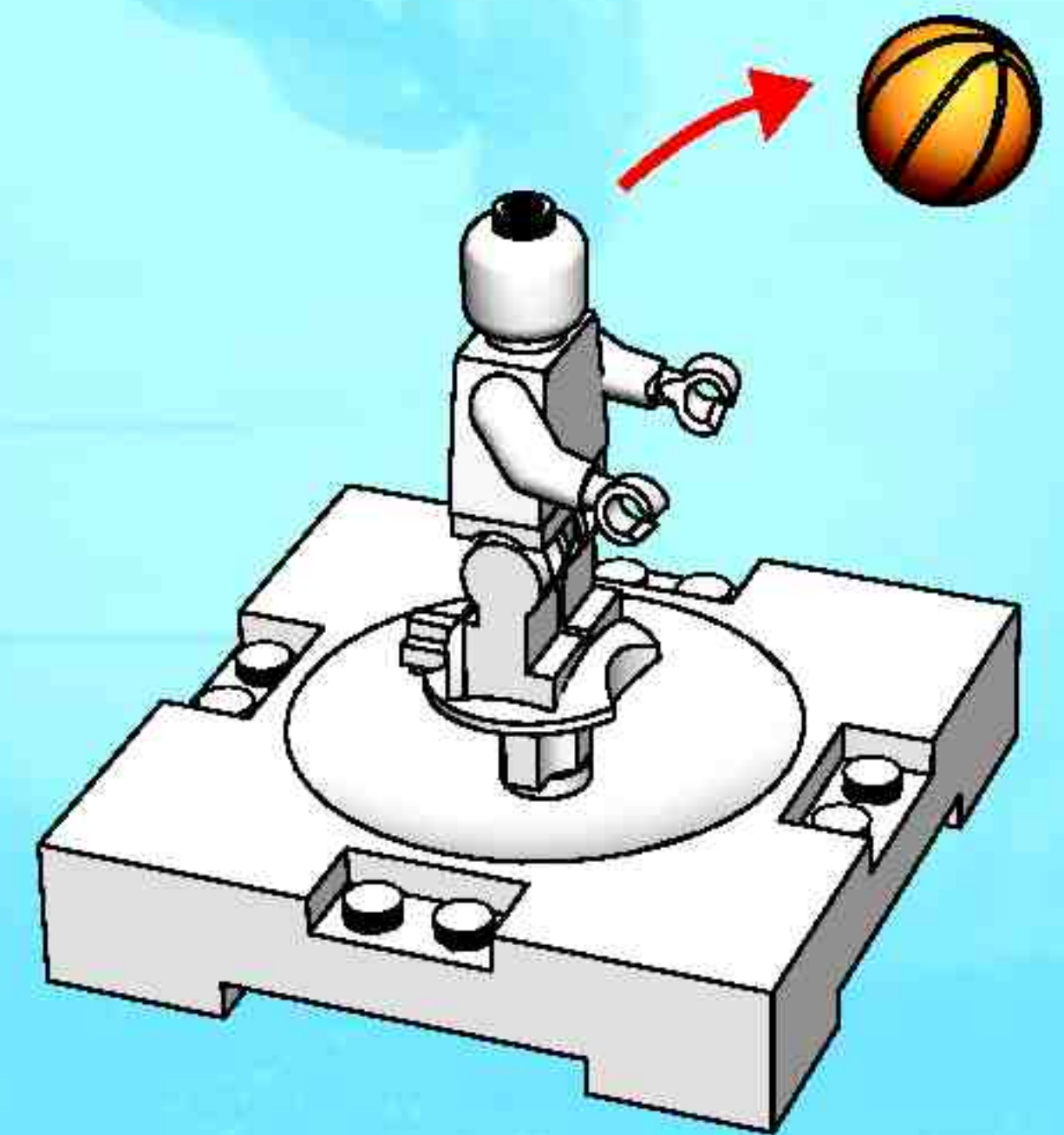

1

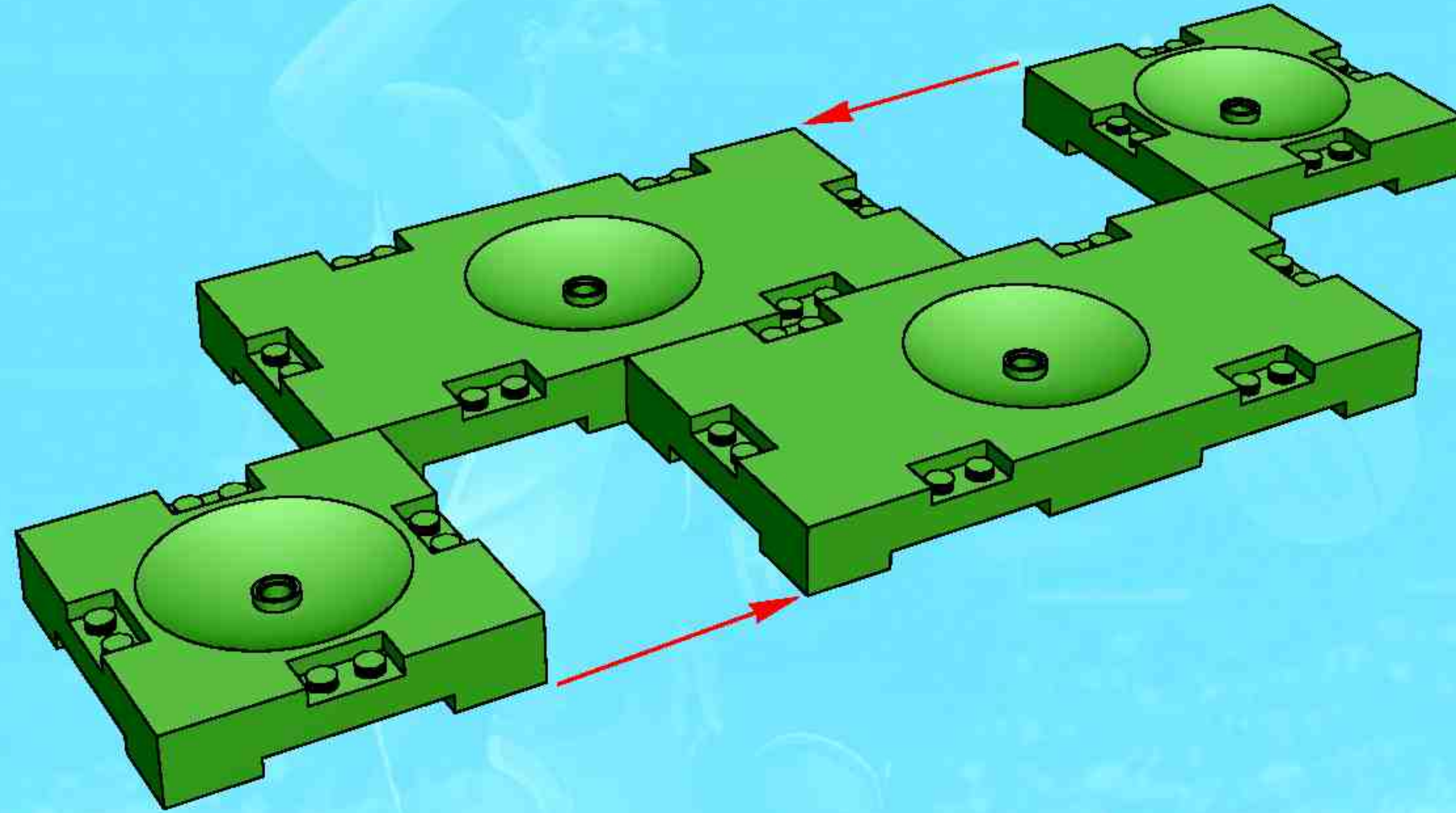

2

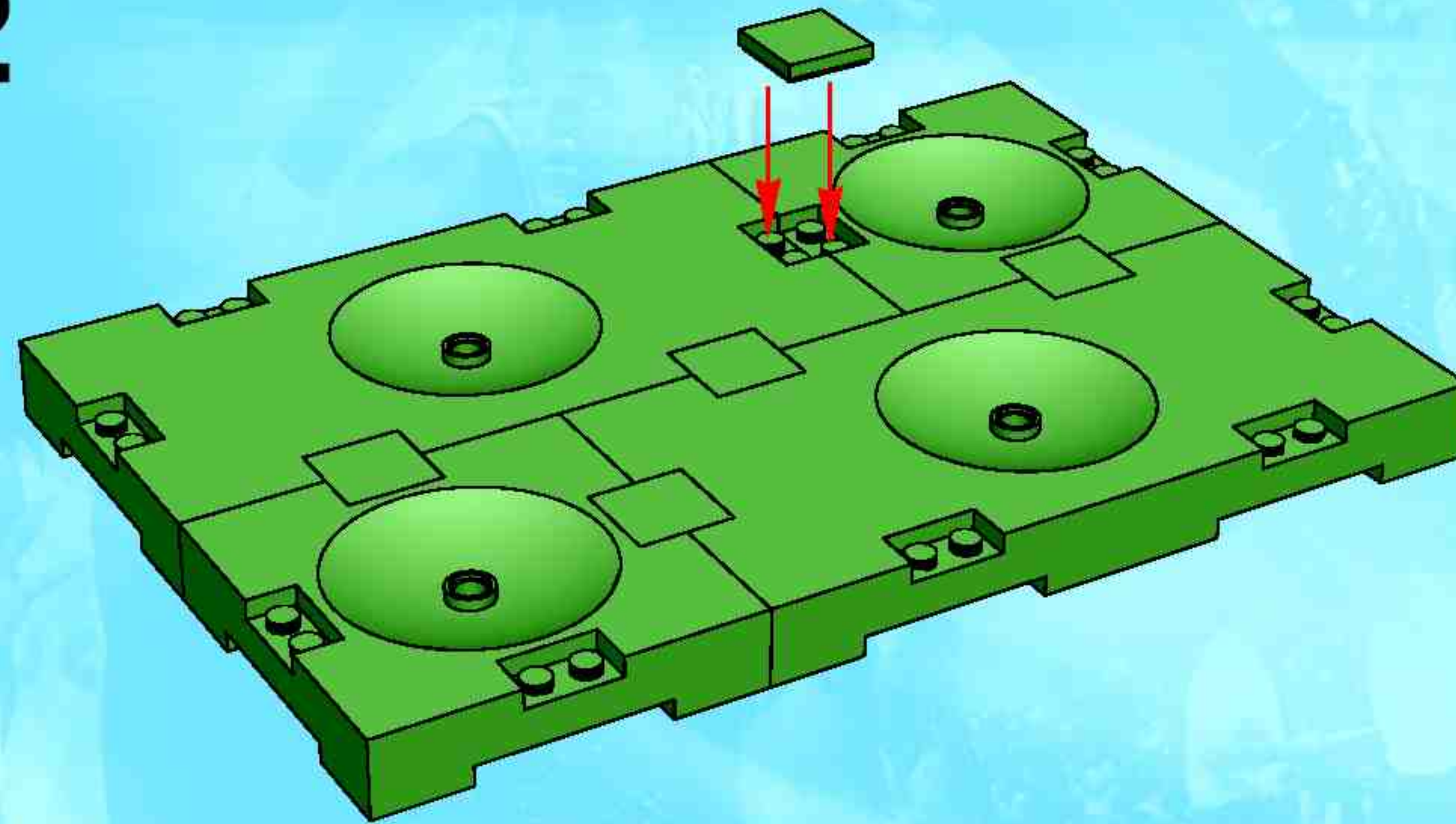

3

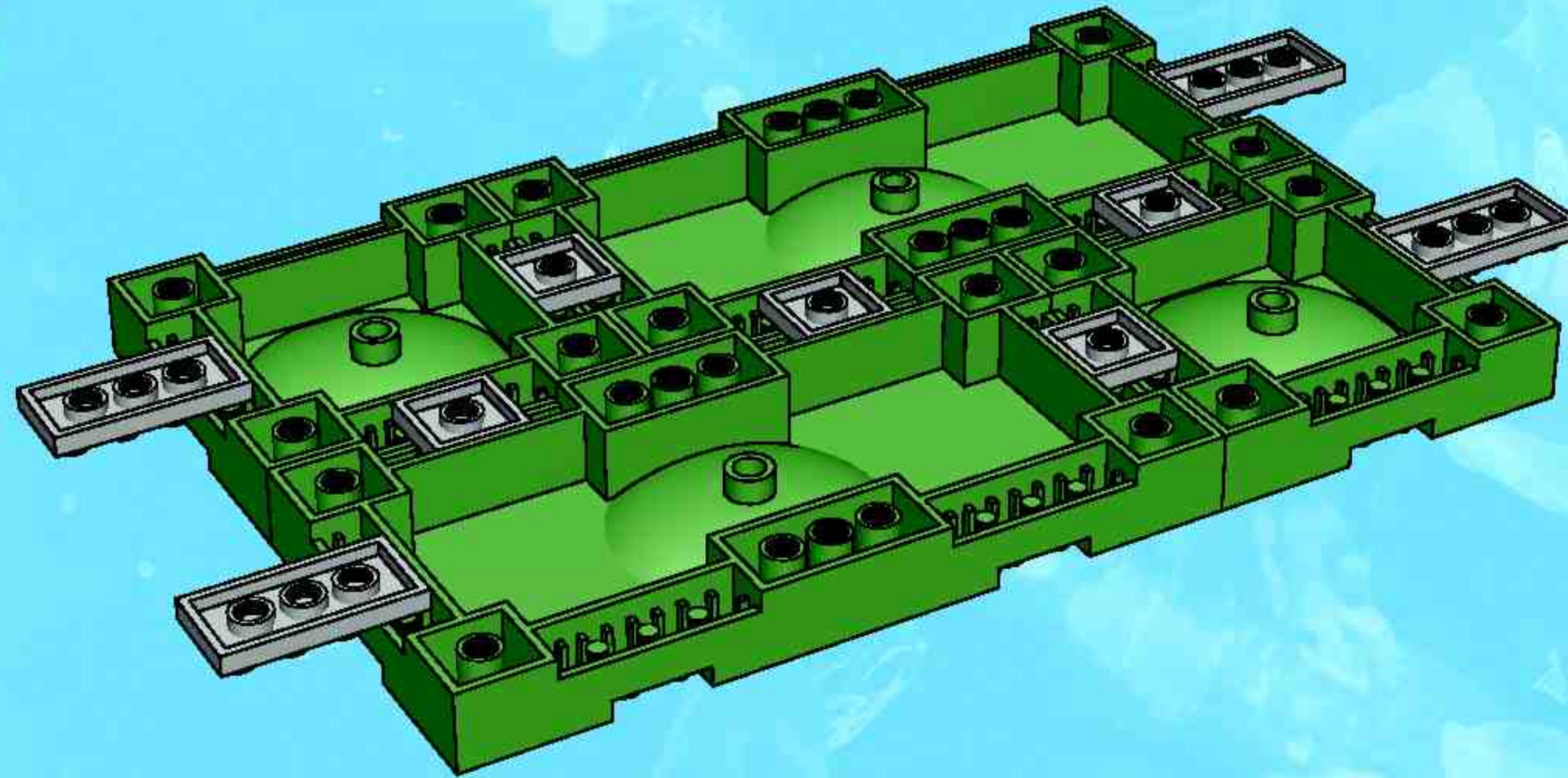

4

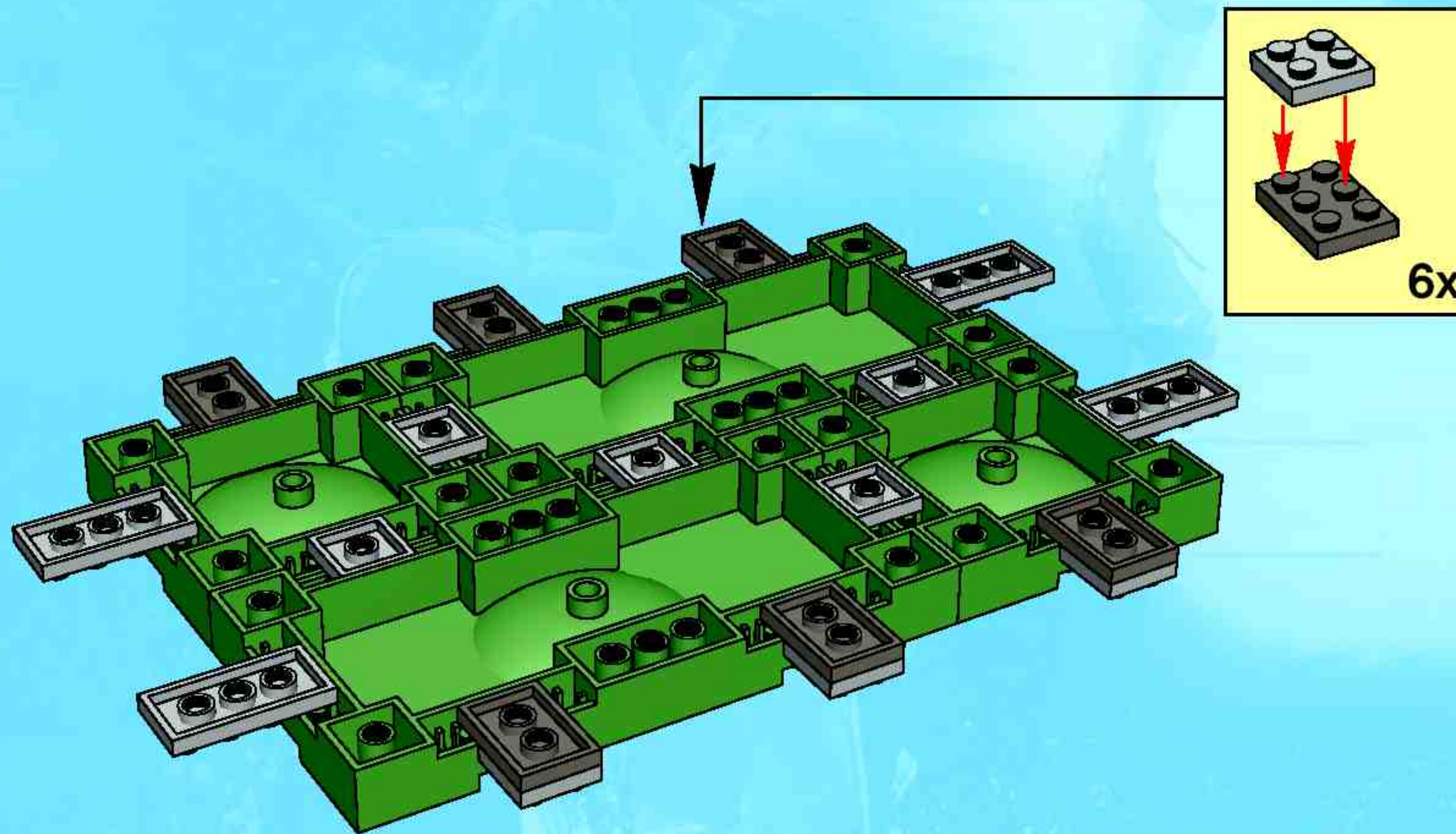

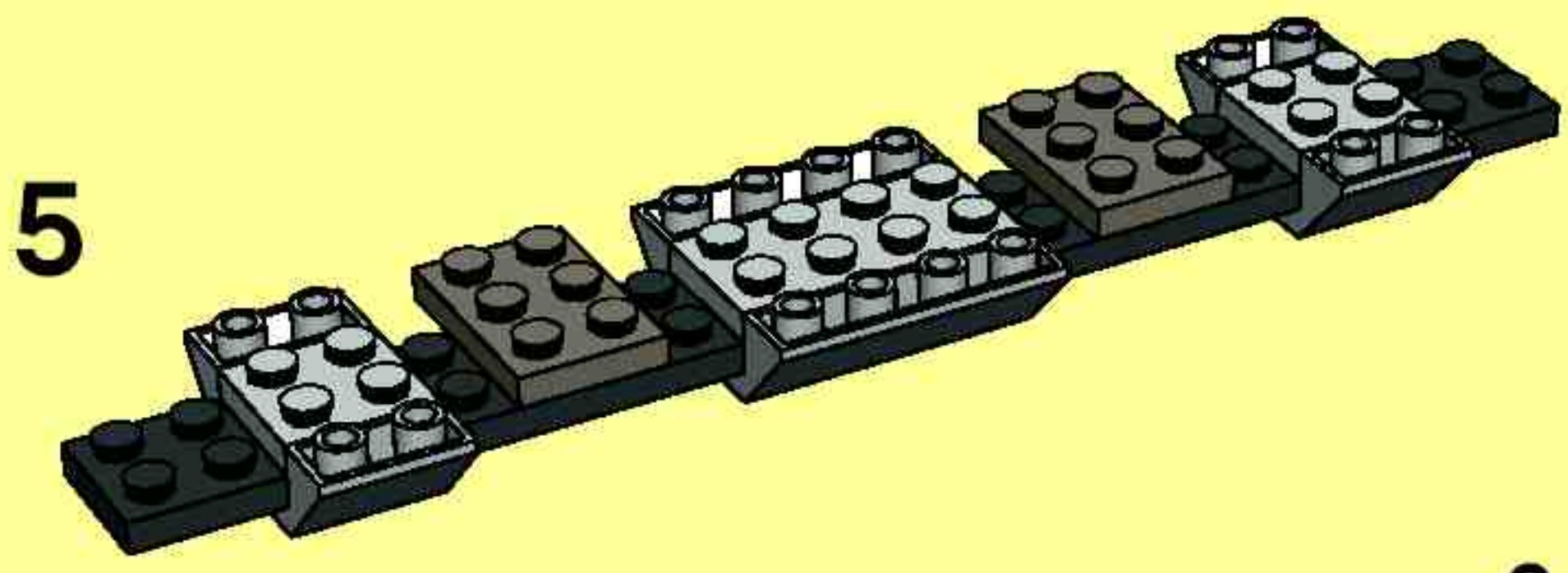
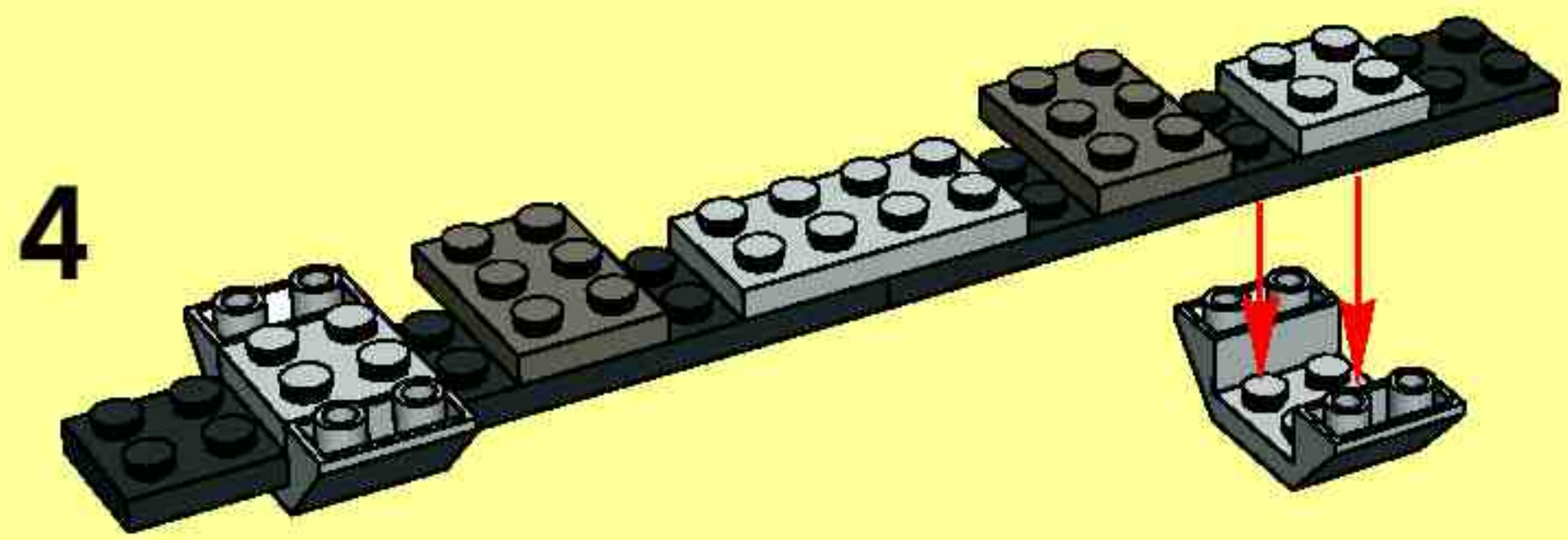
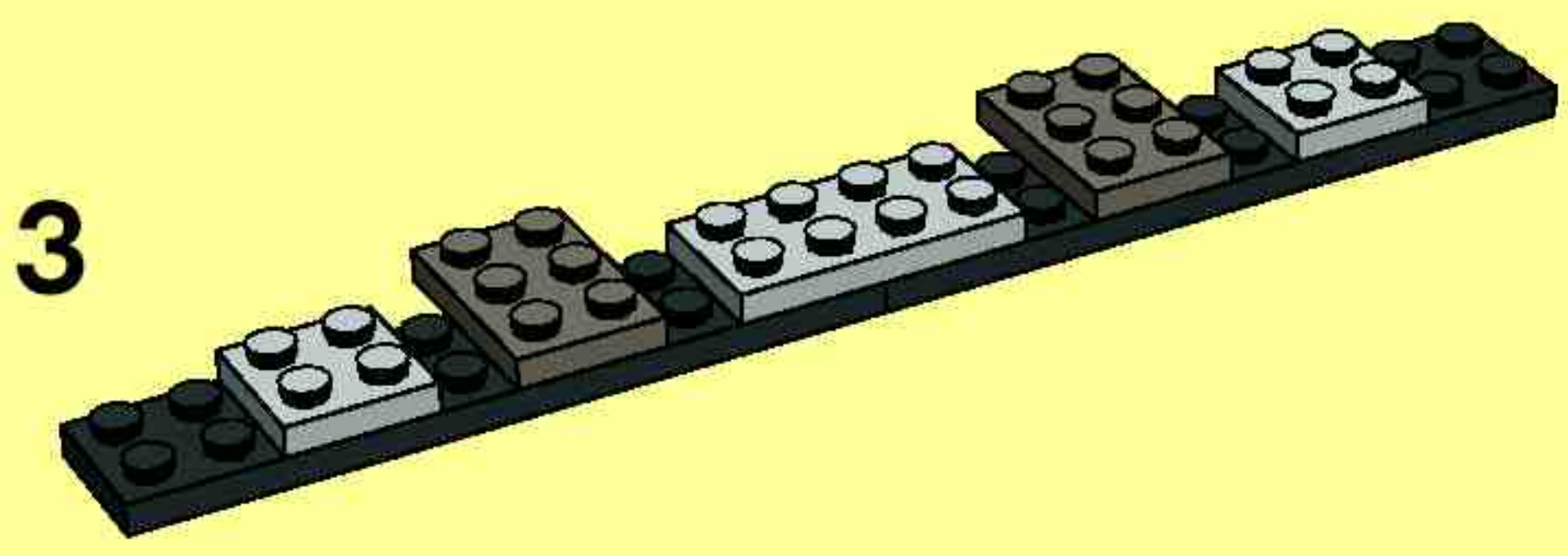
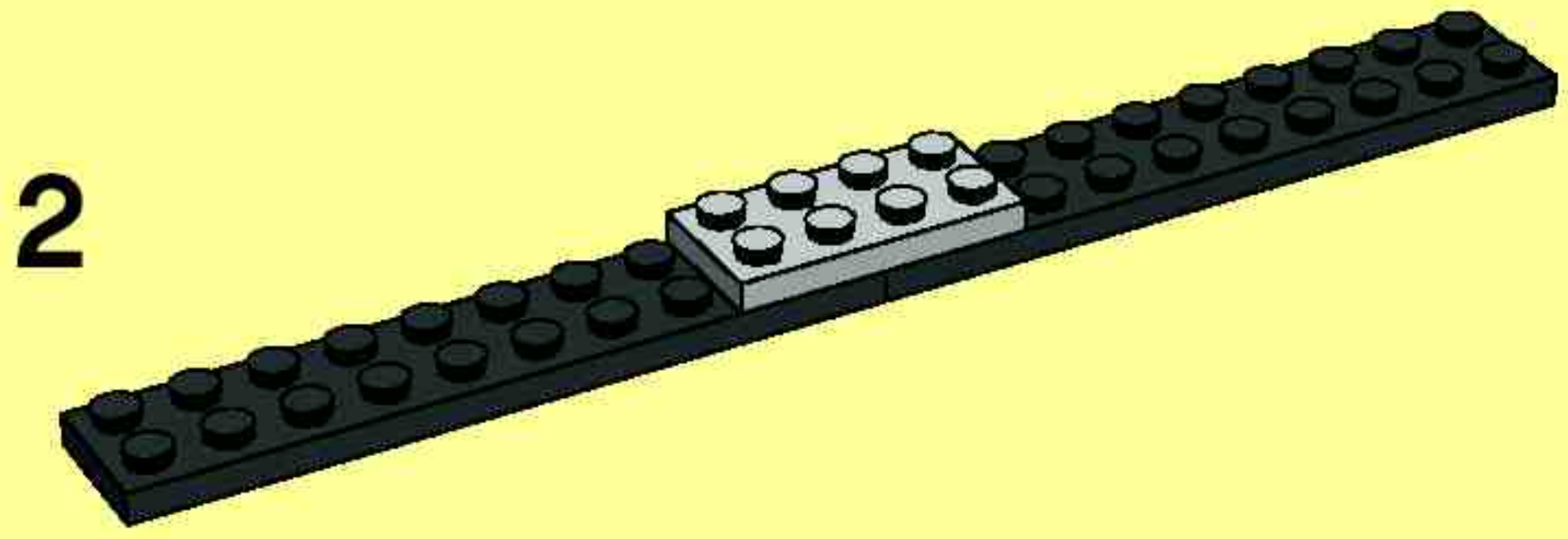
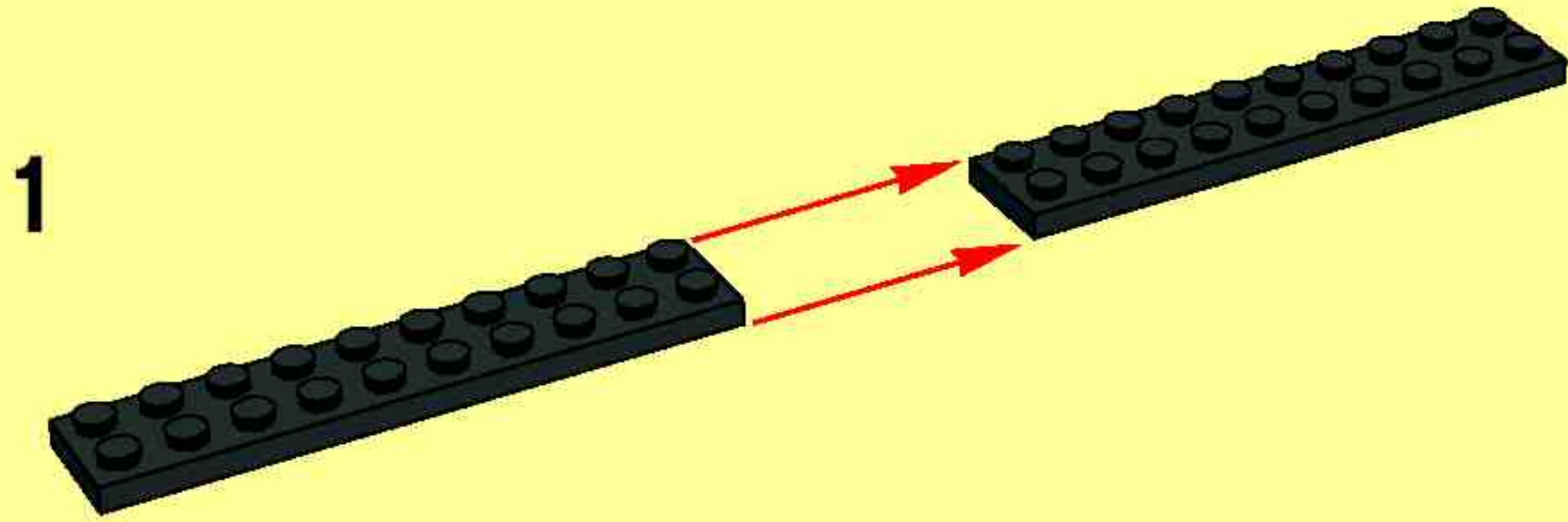

2x

5

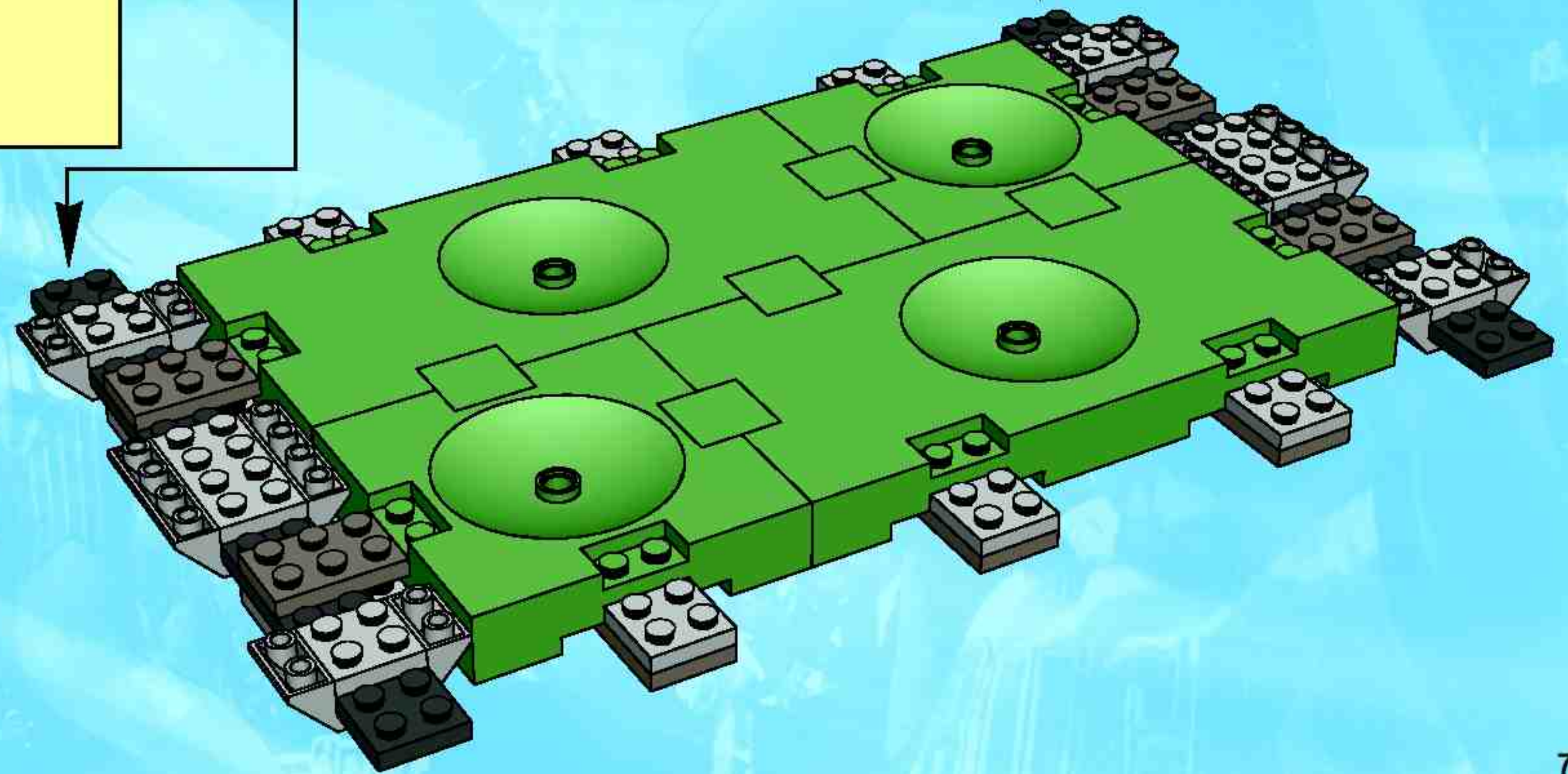

6

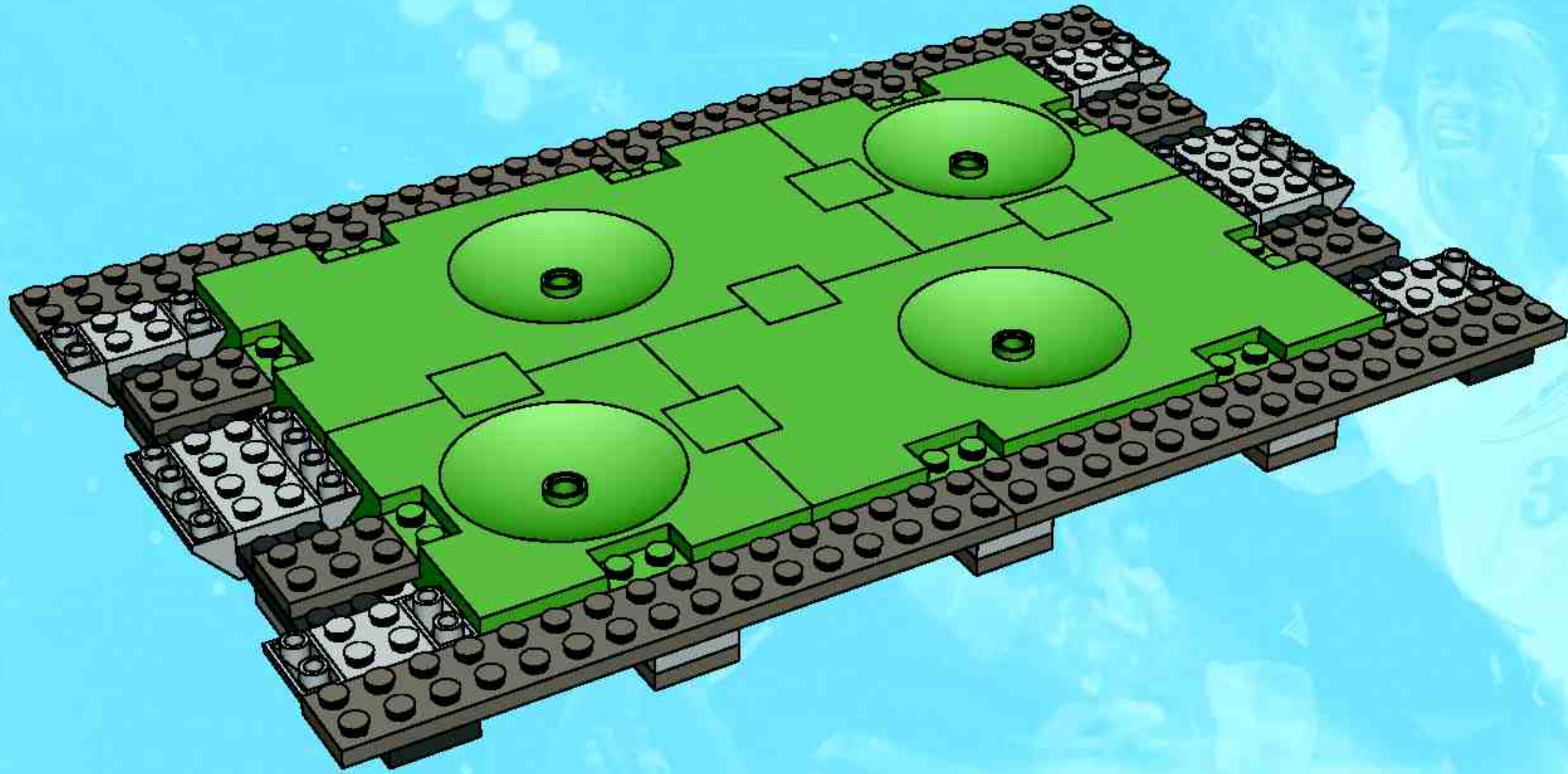

7

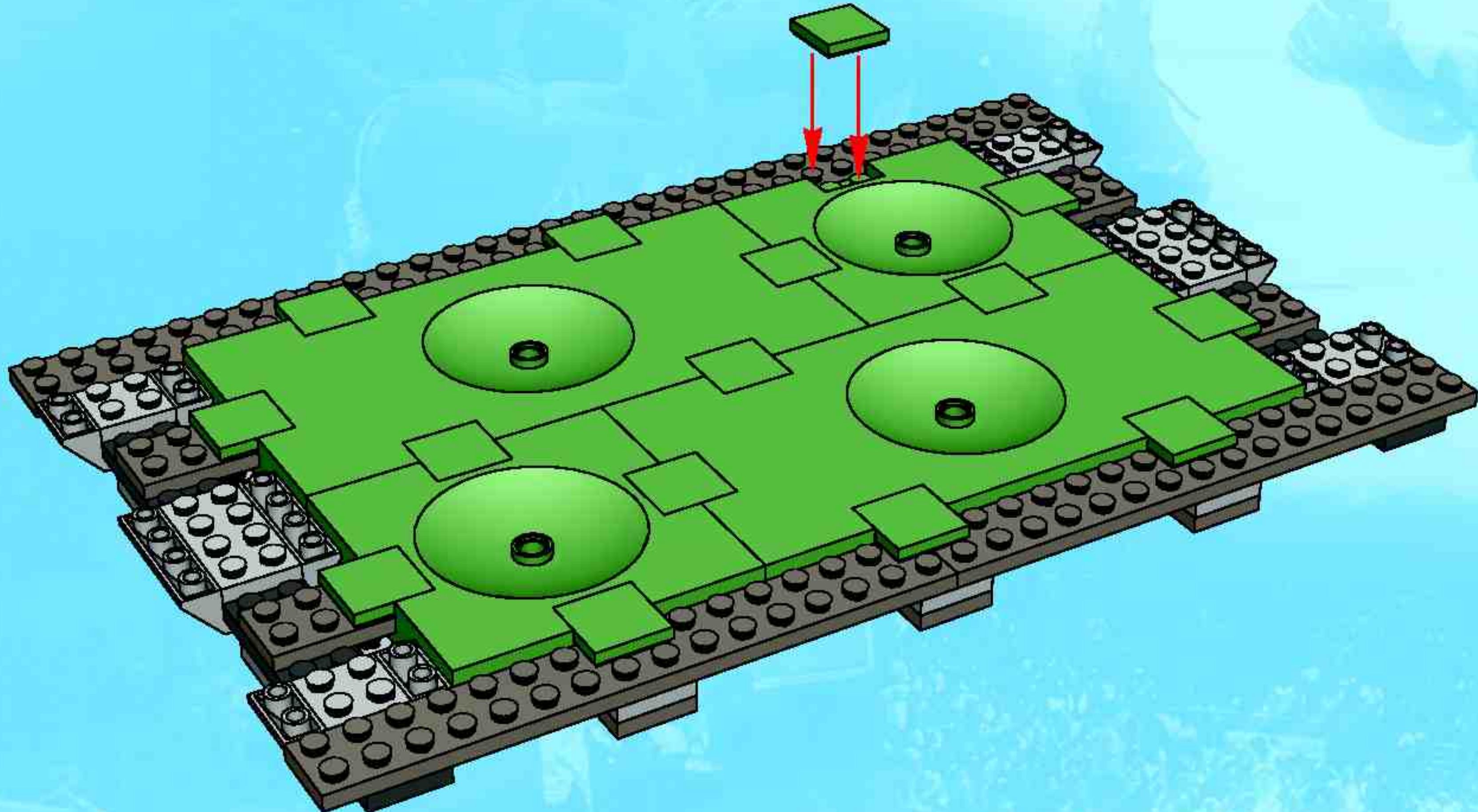

8

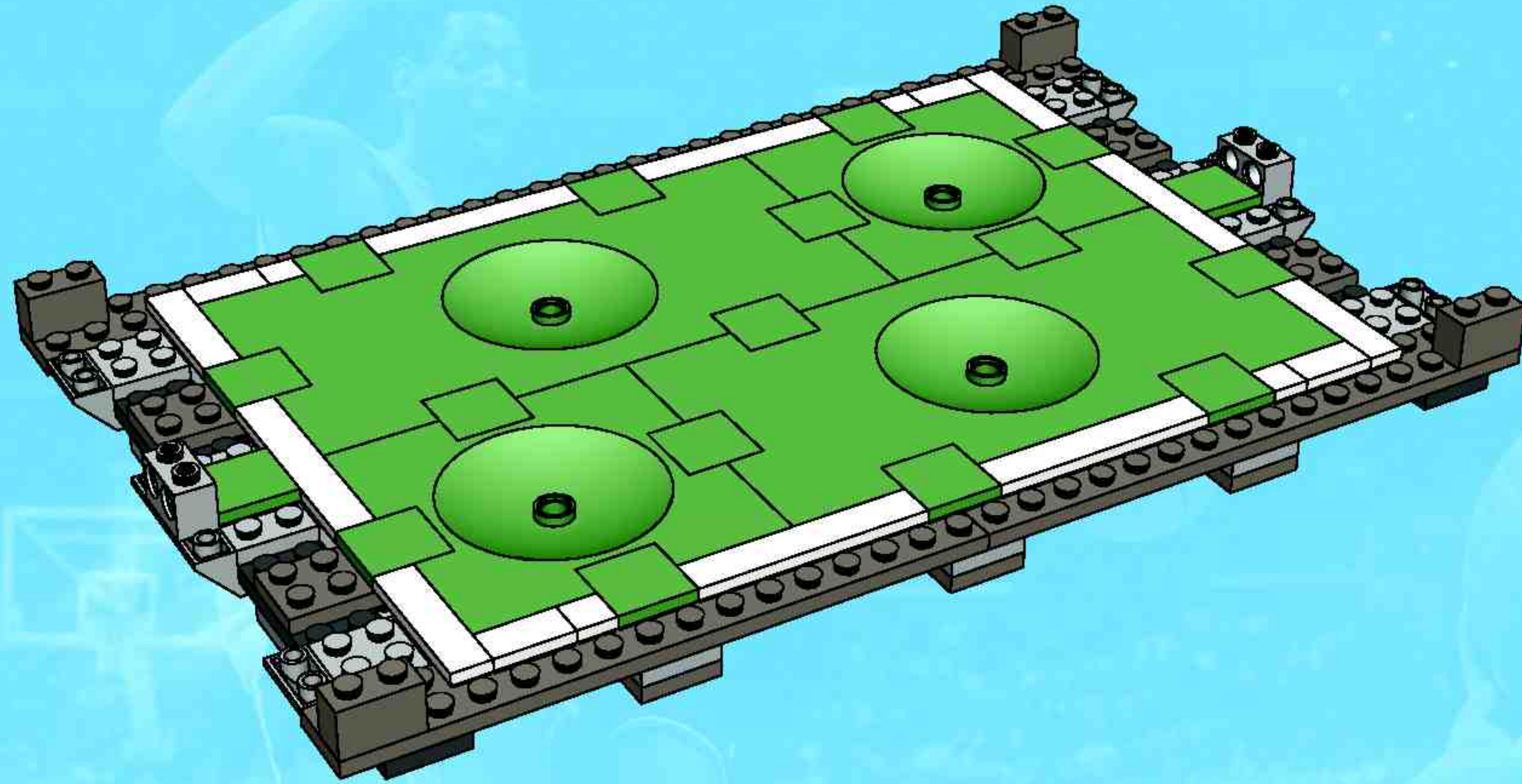

9

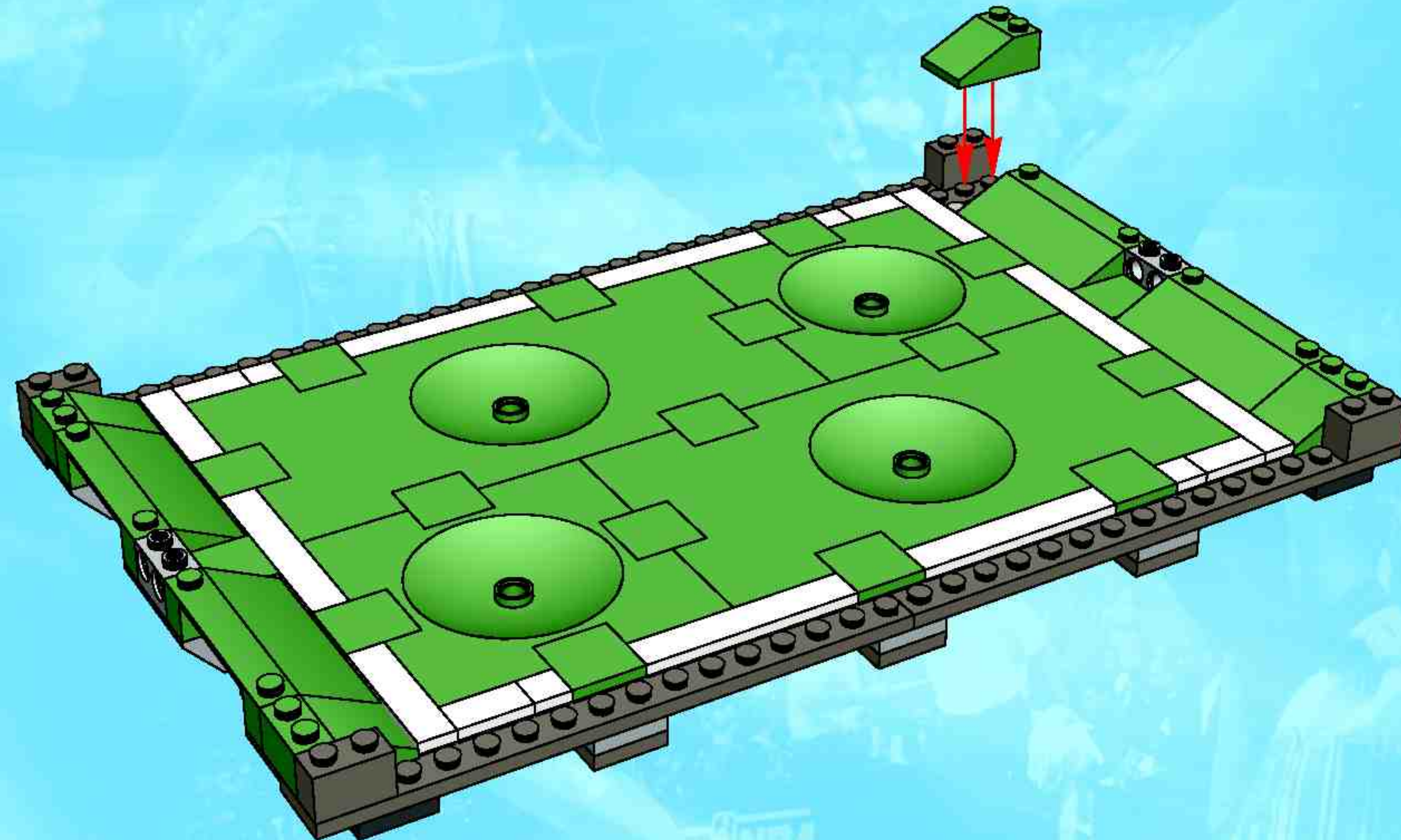

10

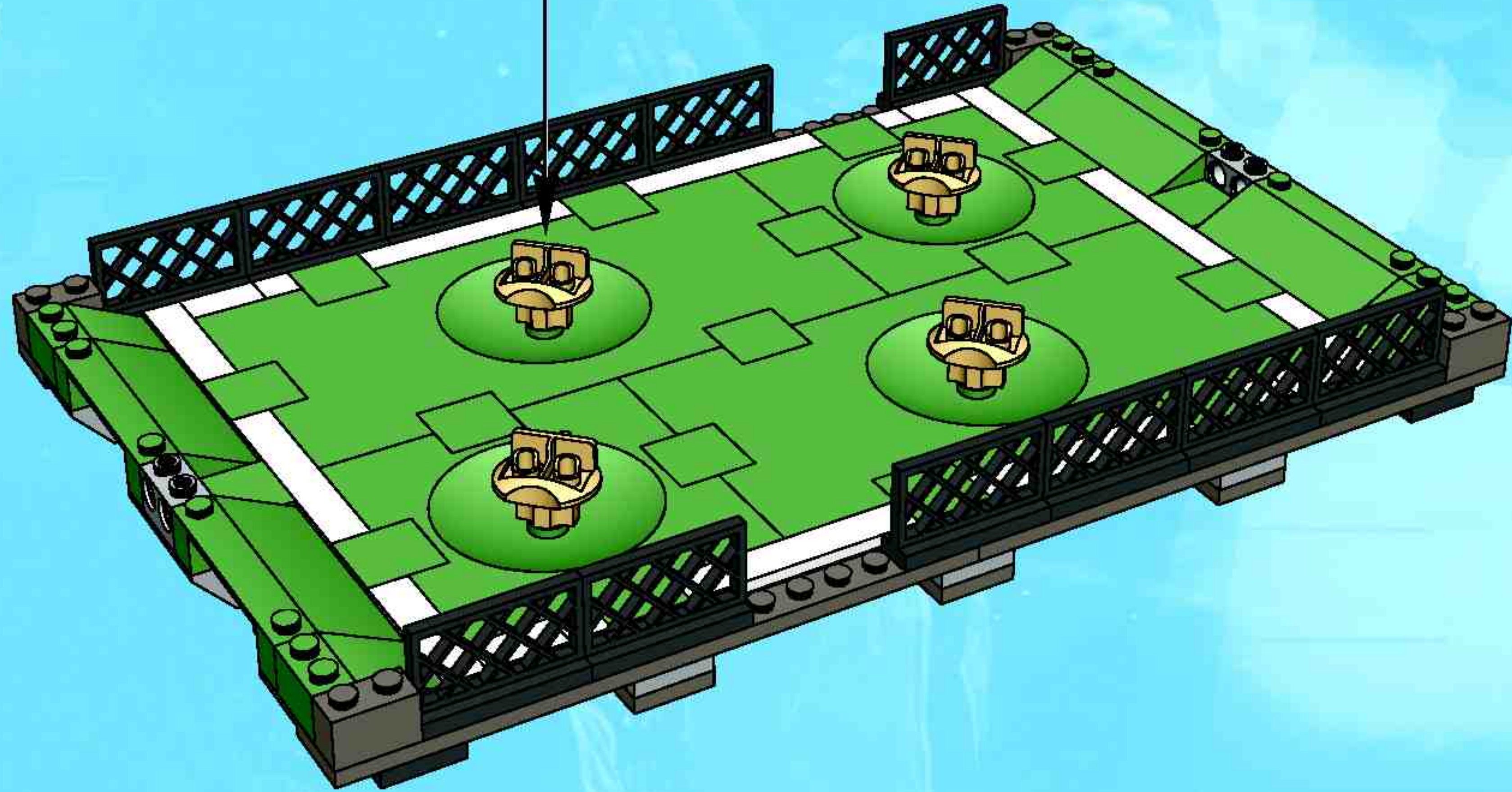
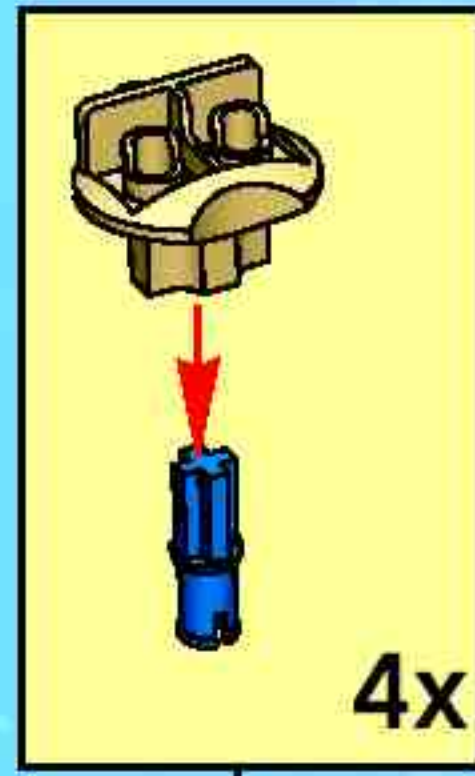

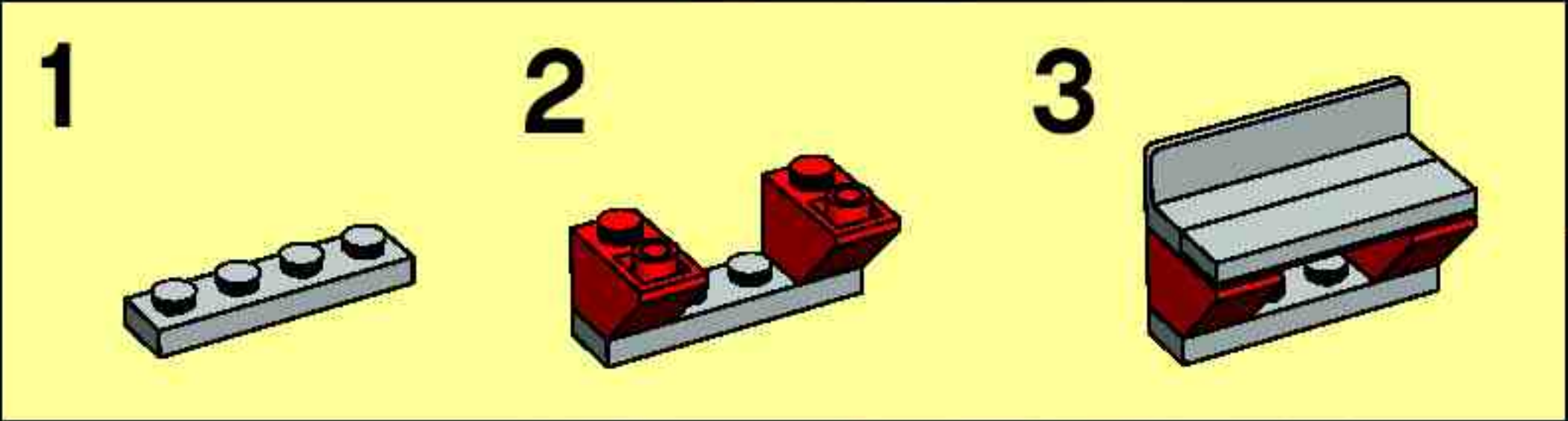

11

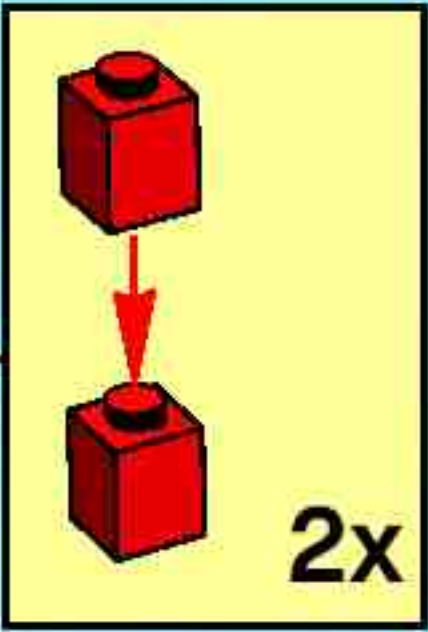
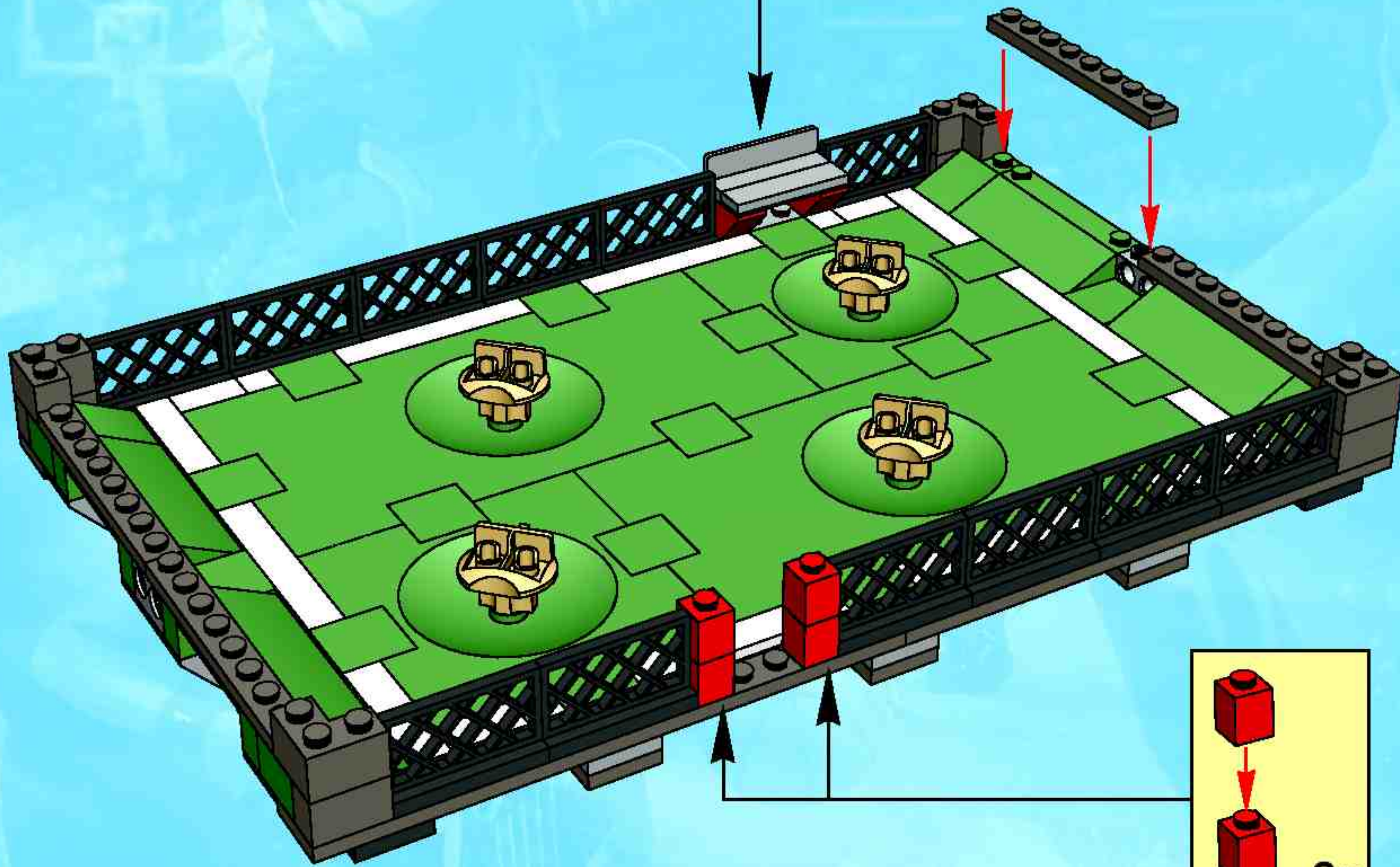

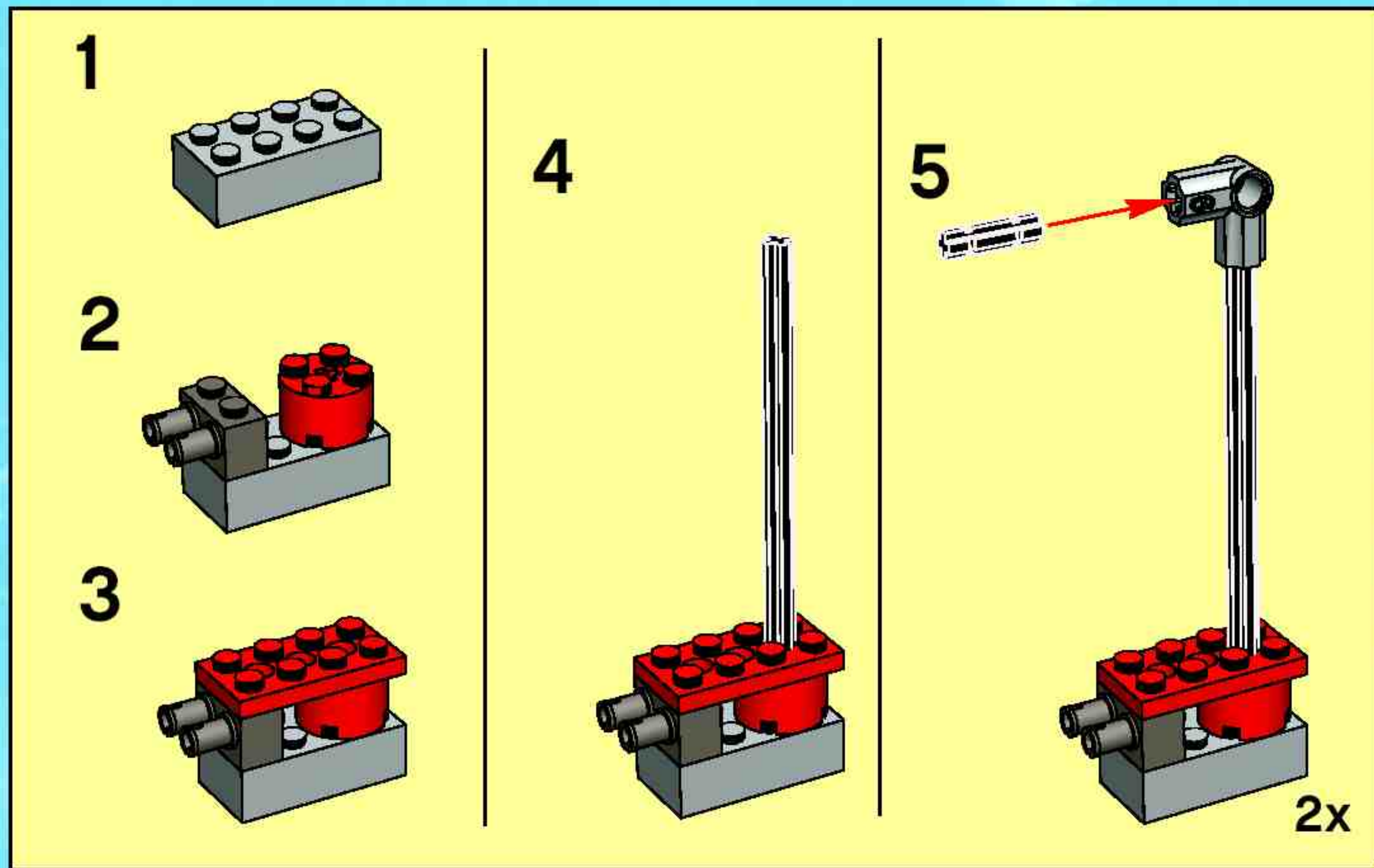

12



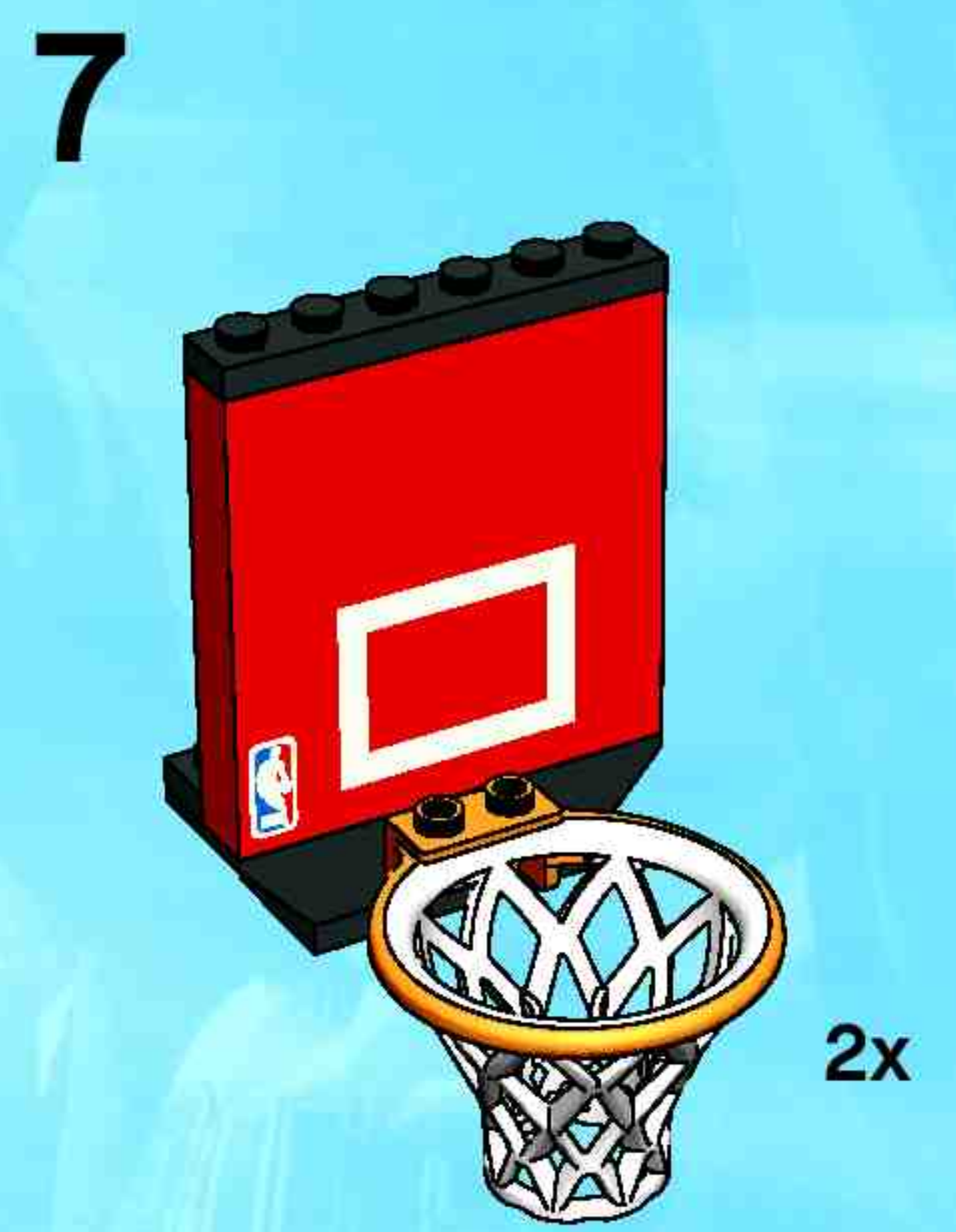
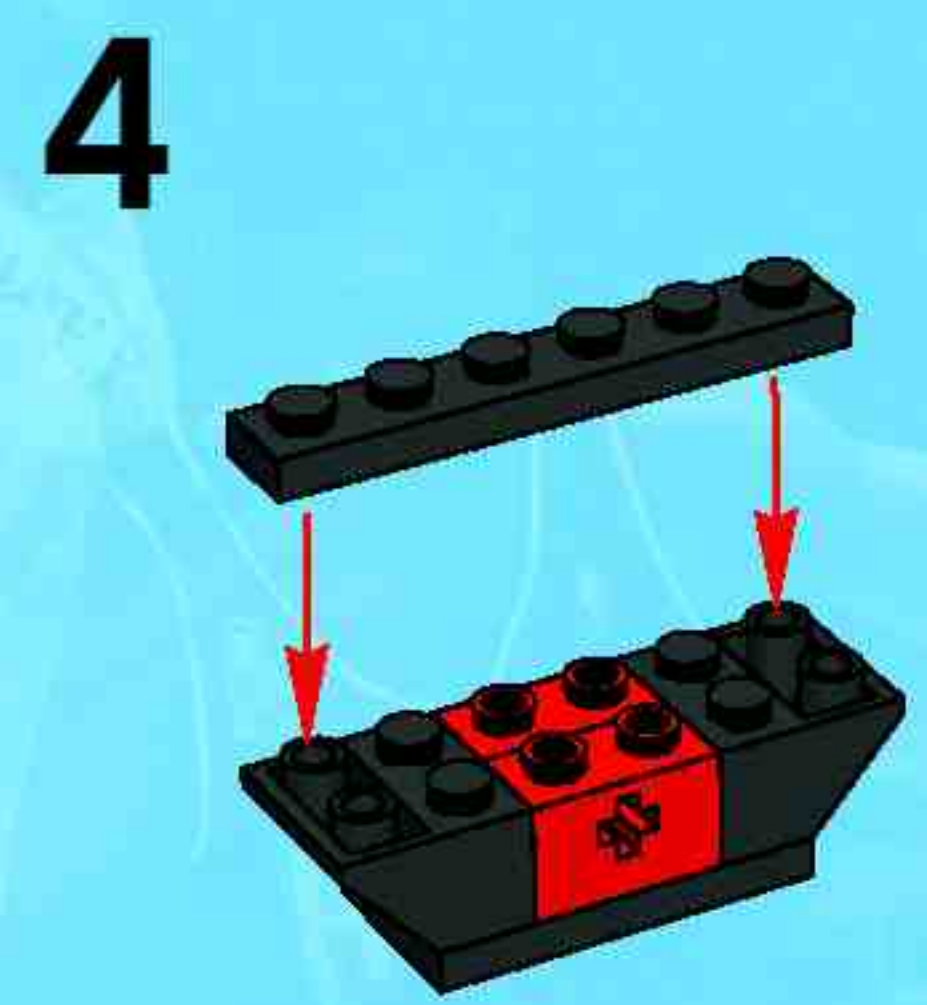
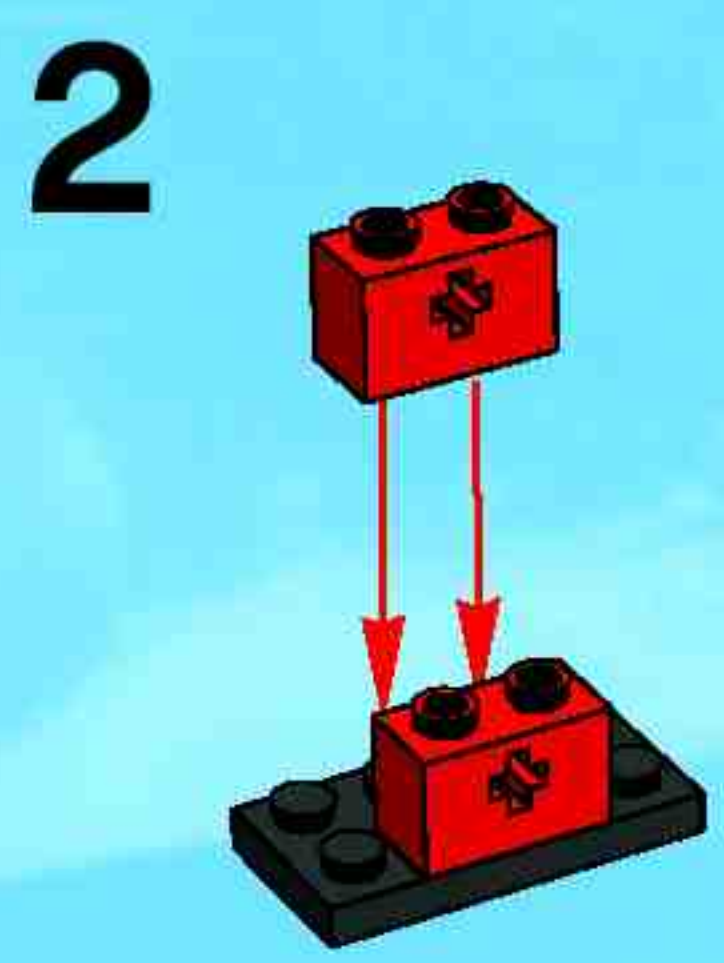

13



14





www.LEGO.com

NBA.COM

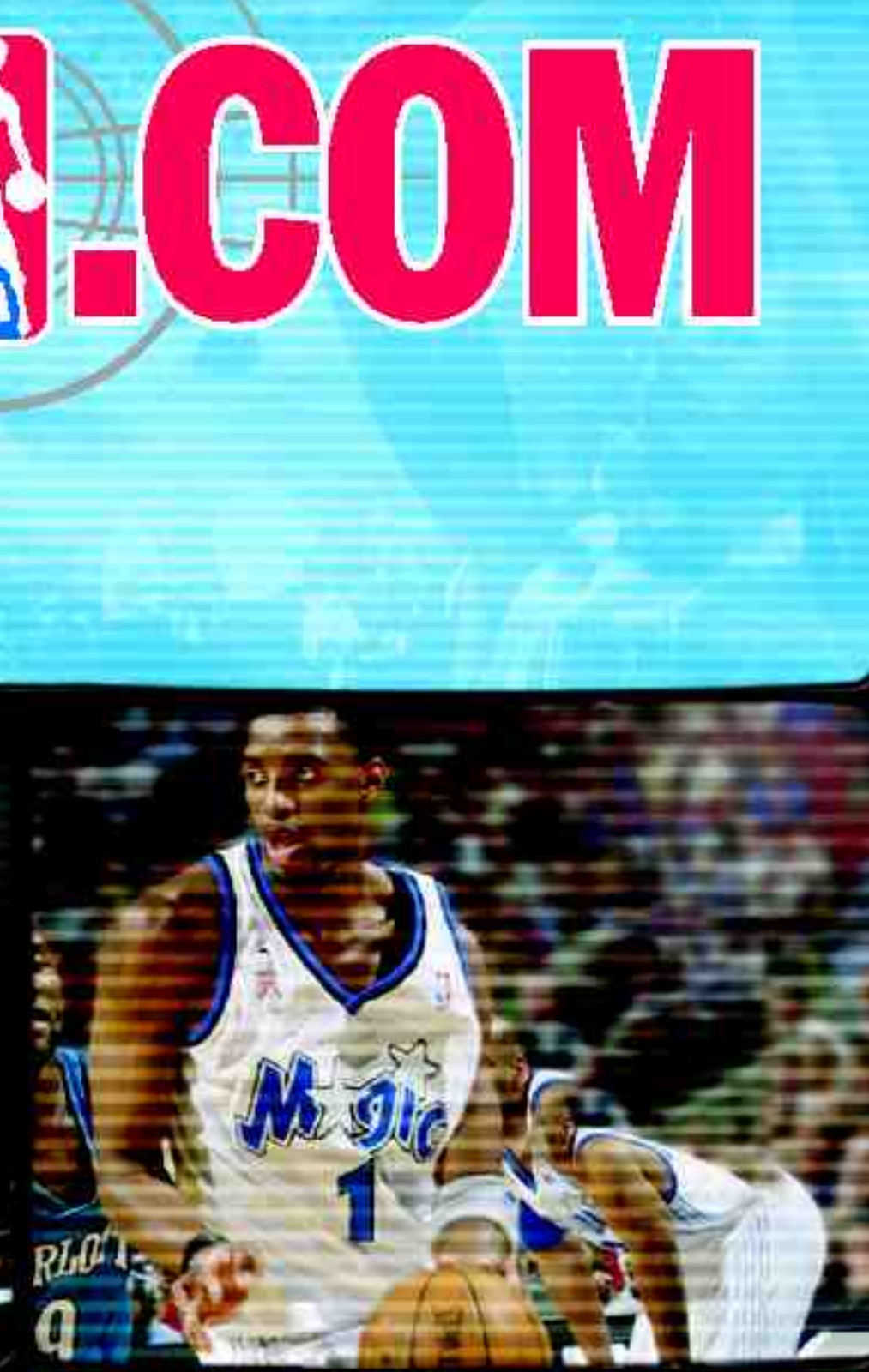



#3428

#3428



#3427 + #3428





3431+3430

1

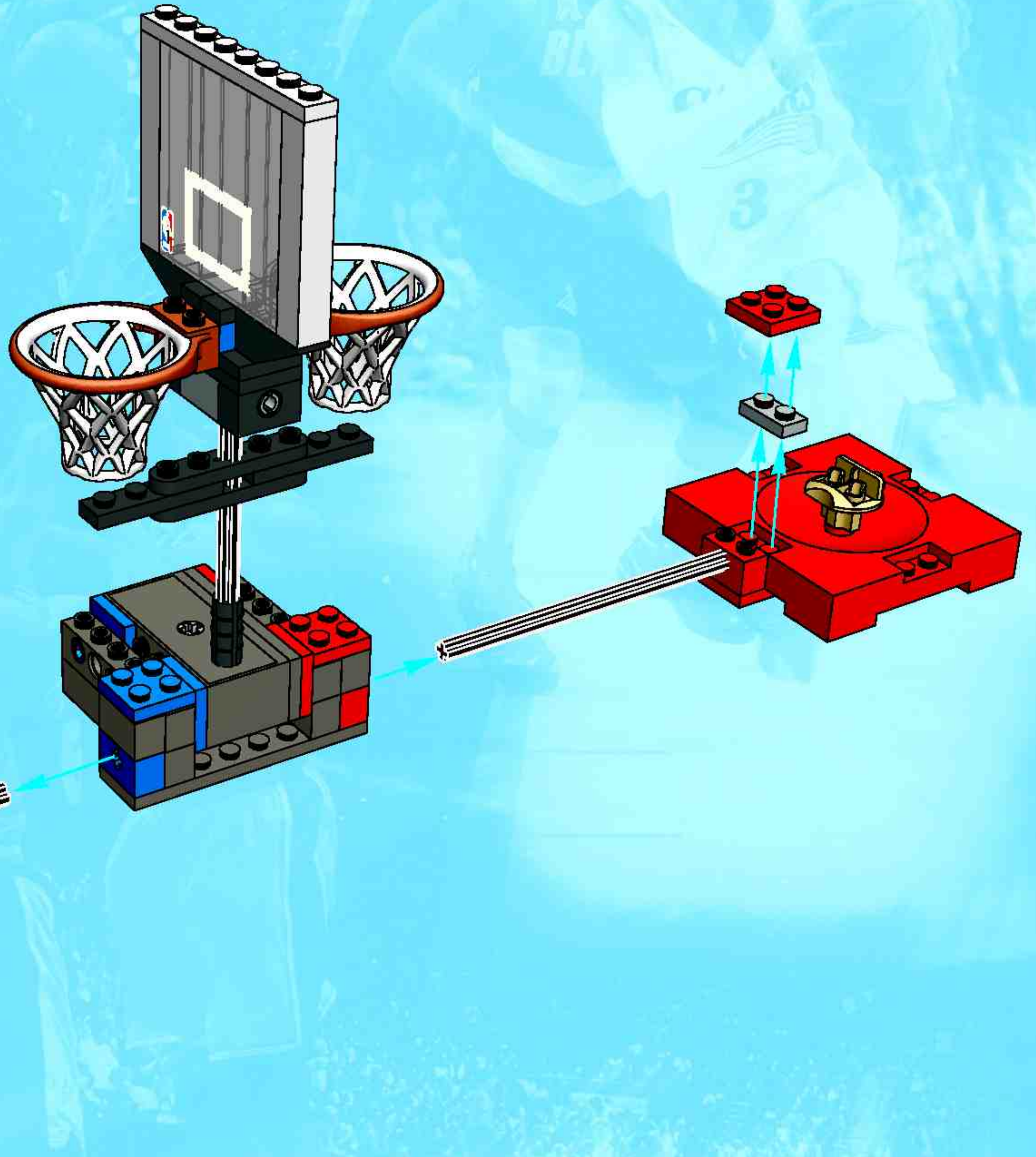

2



3



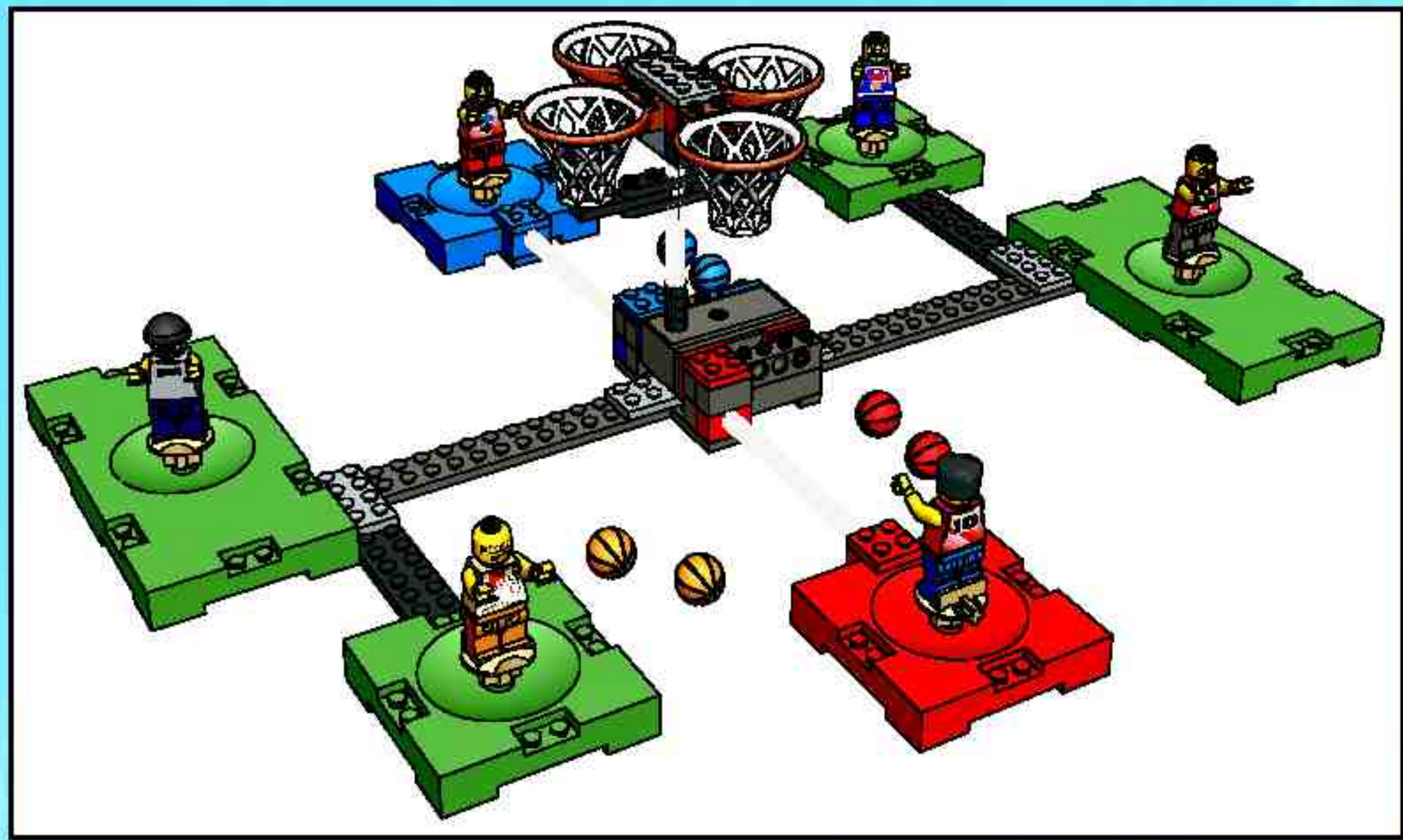

1

3431+3430

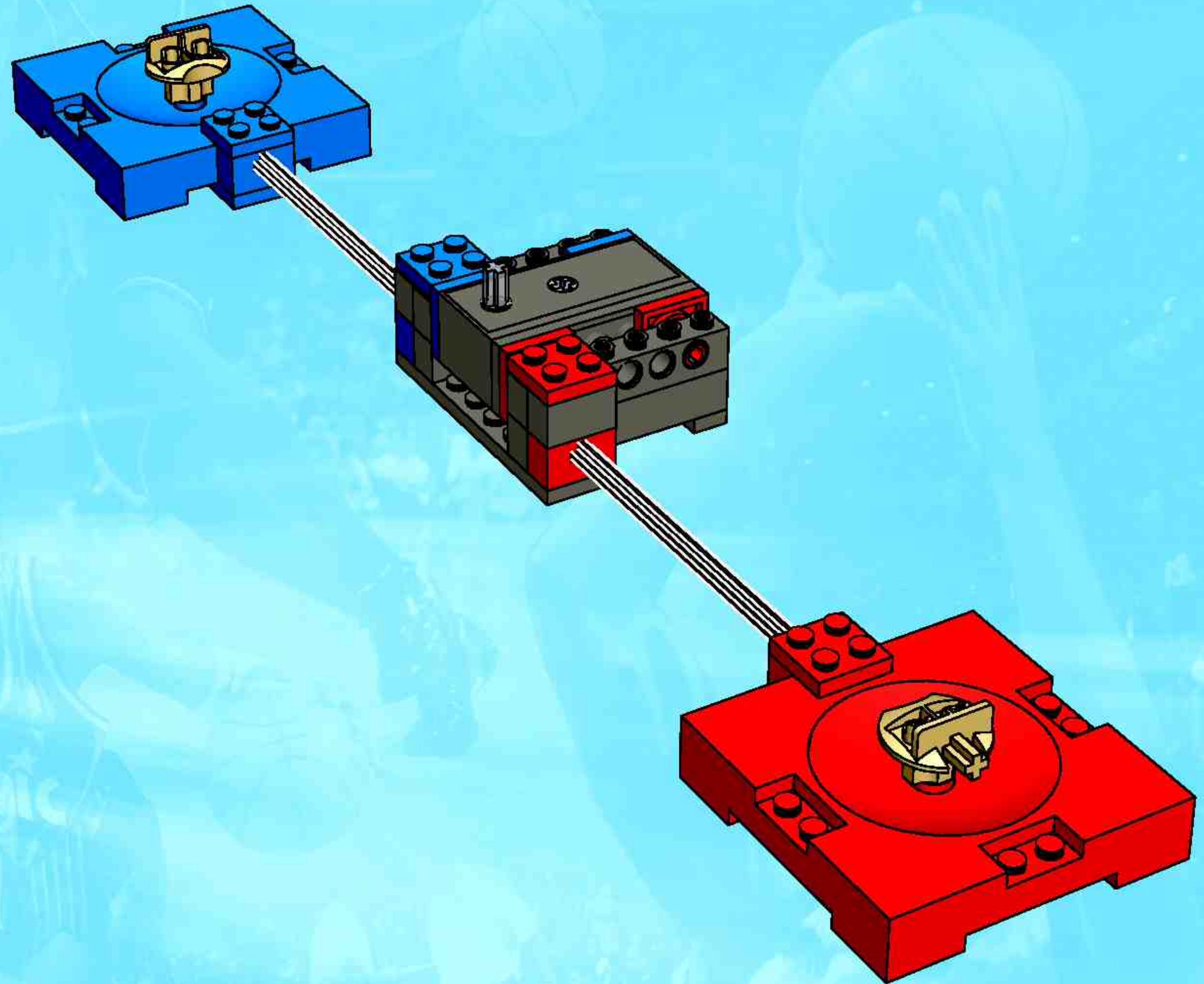

1

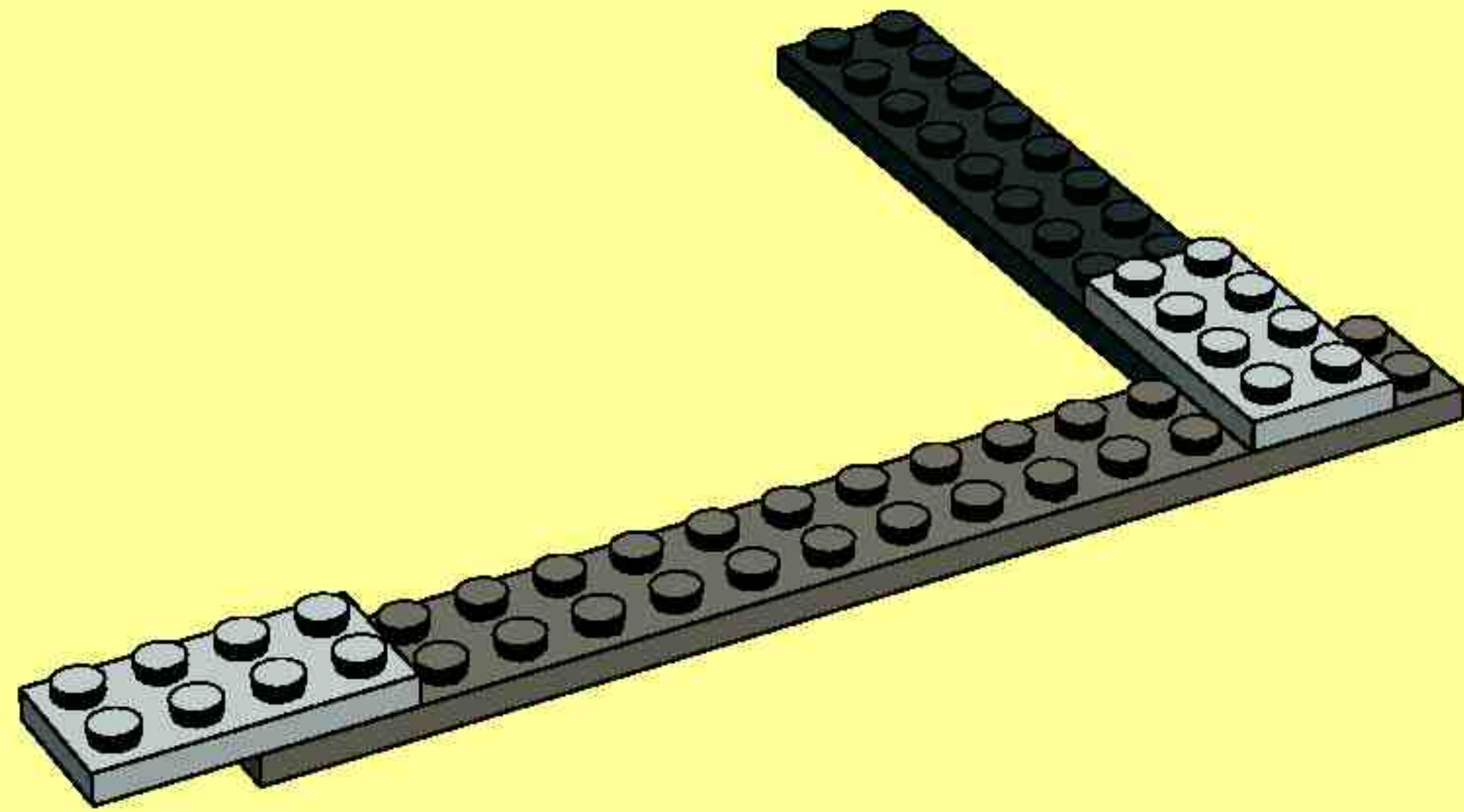

2

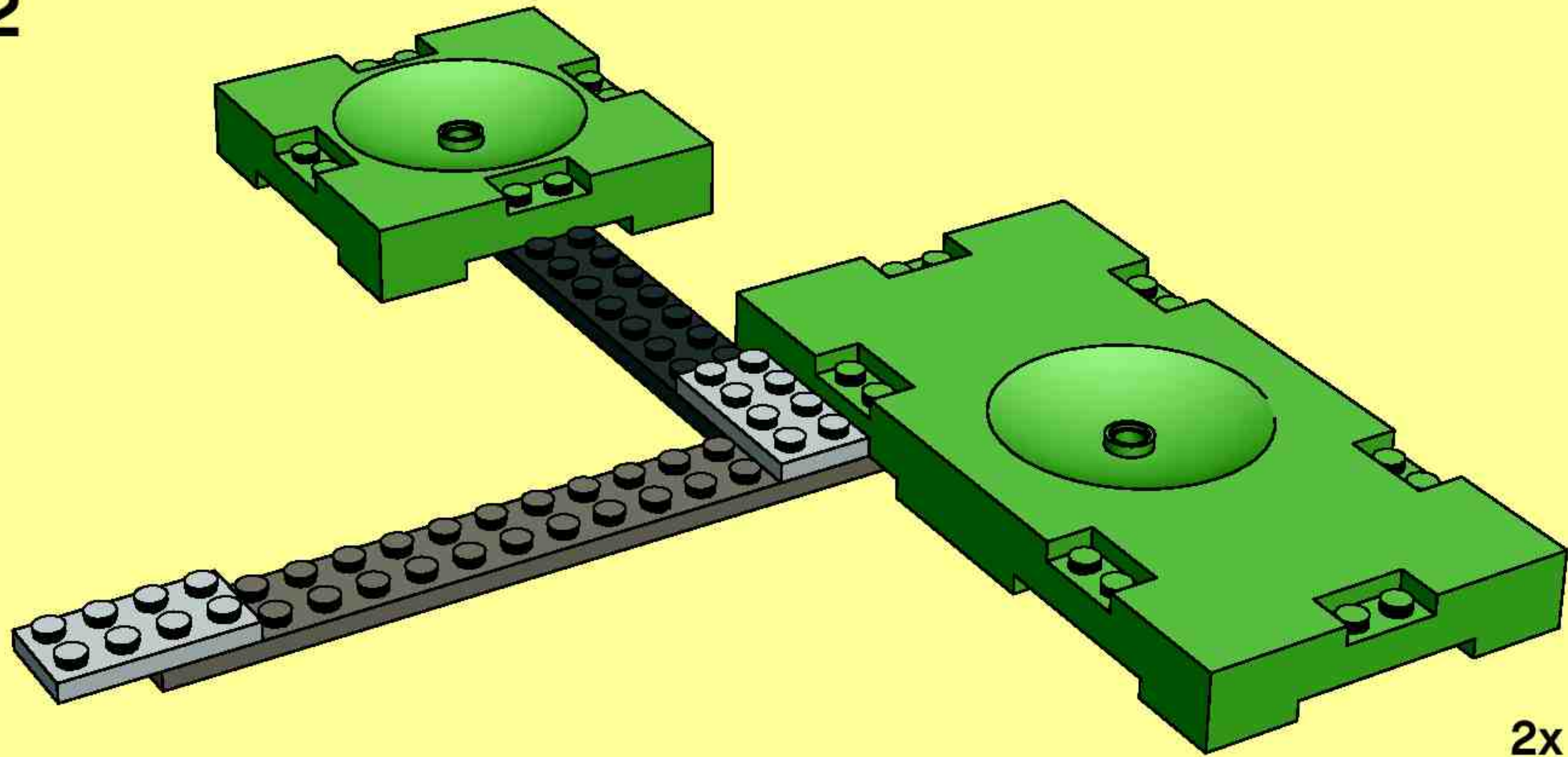

2x

2

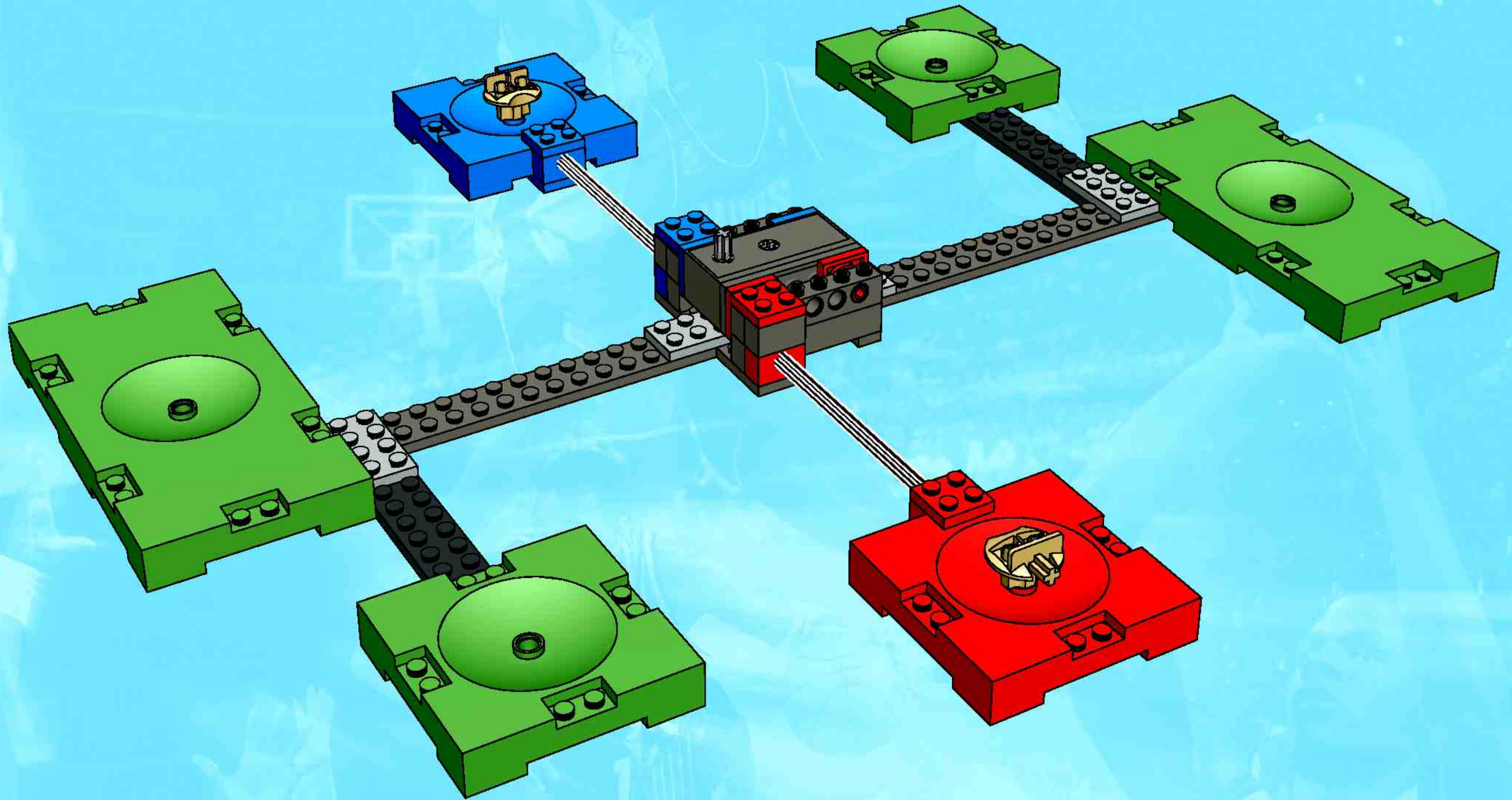

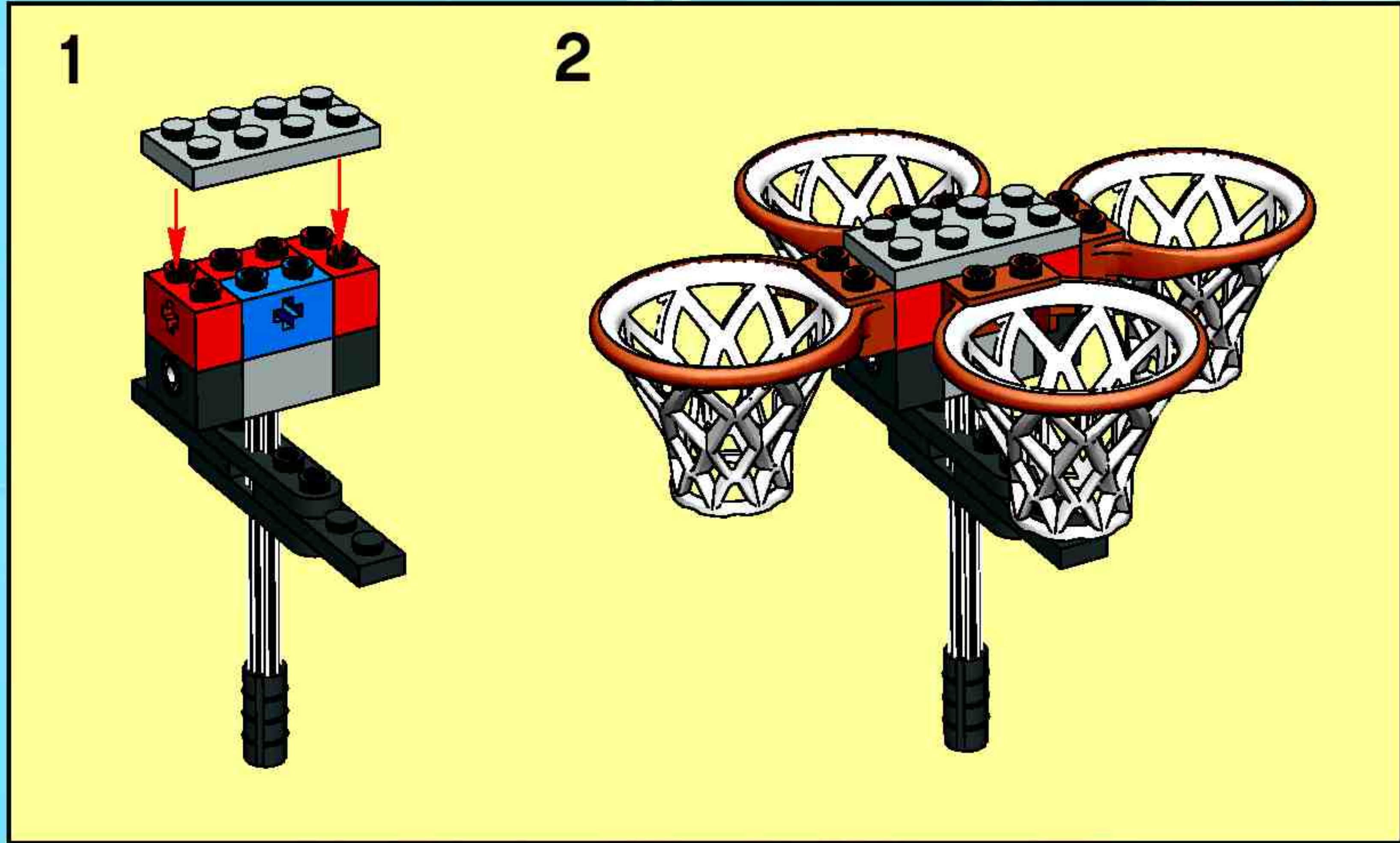

3

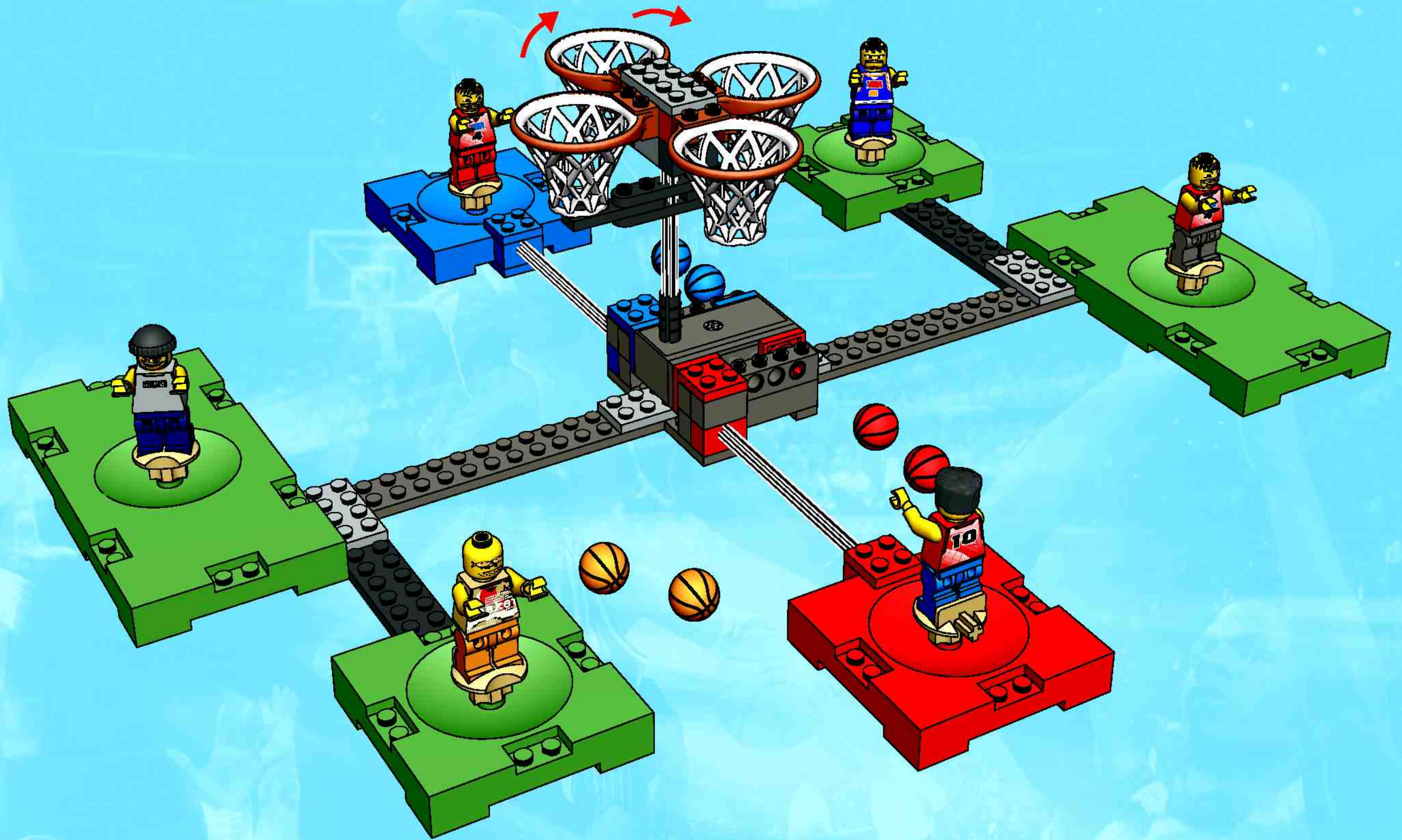



SPORTS

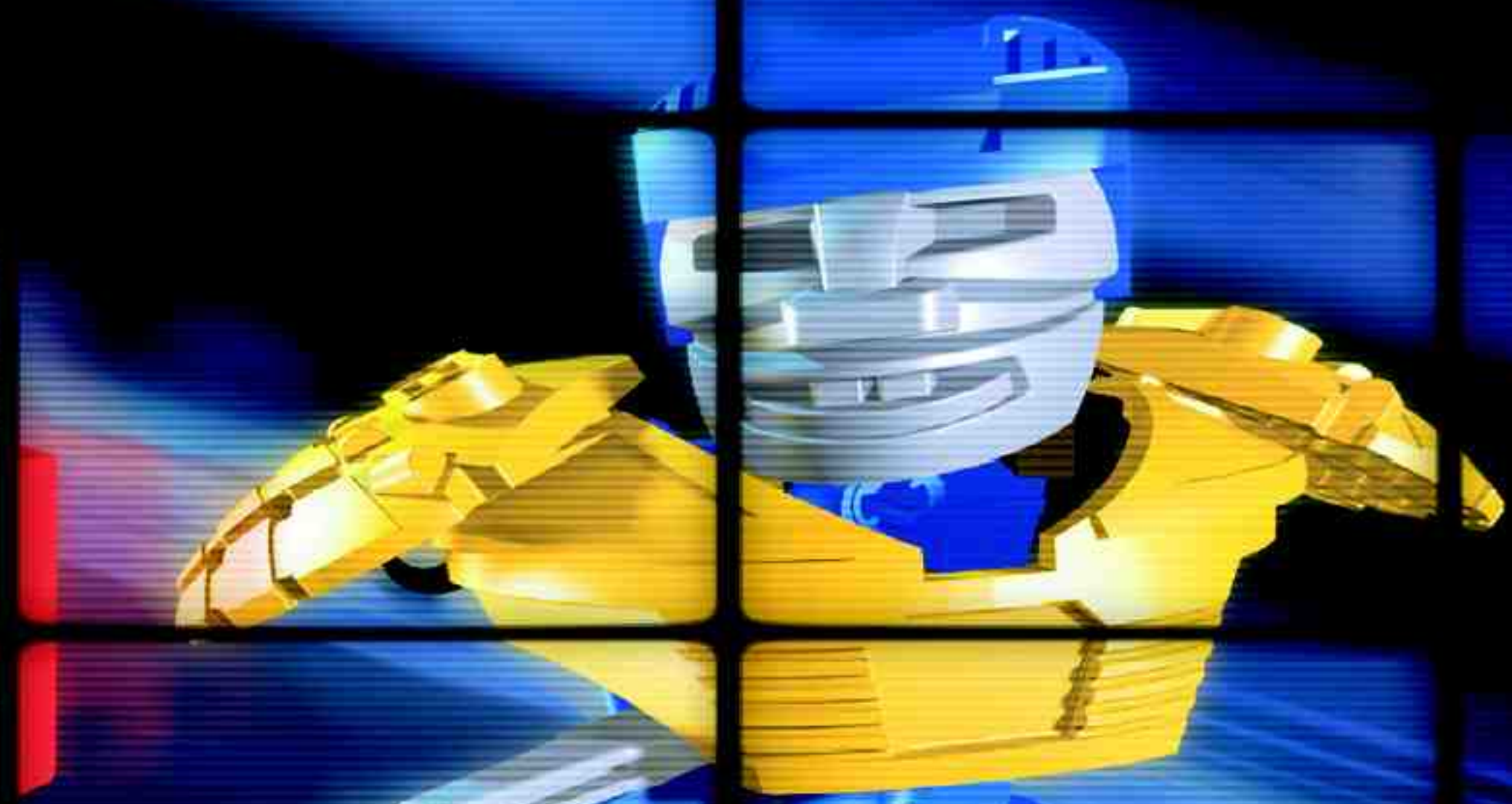
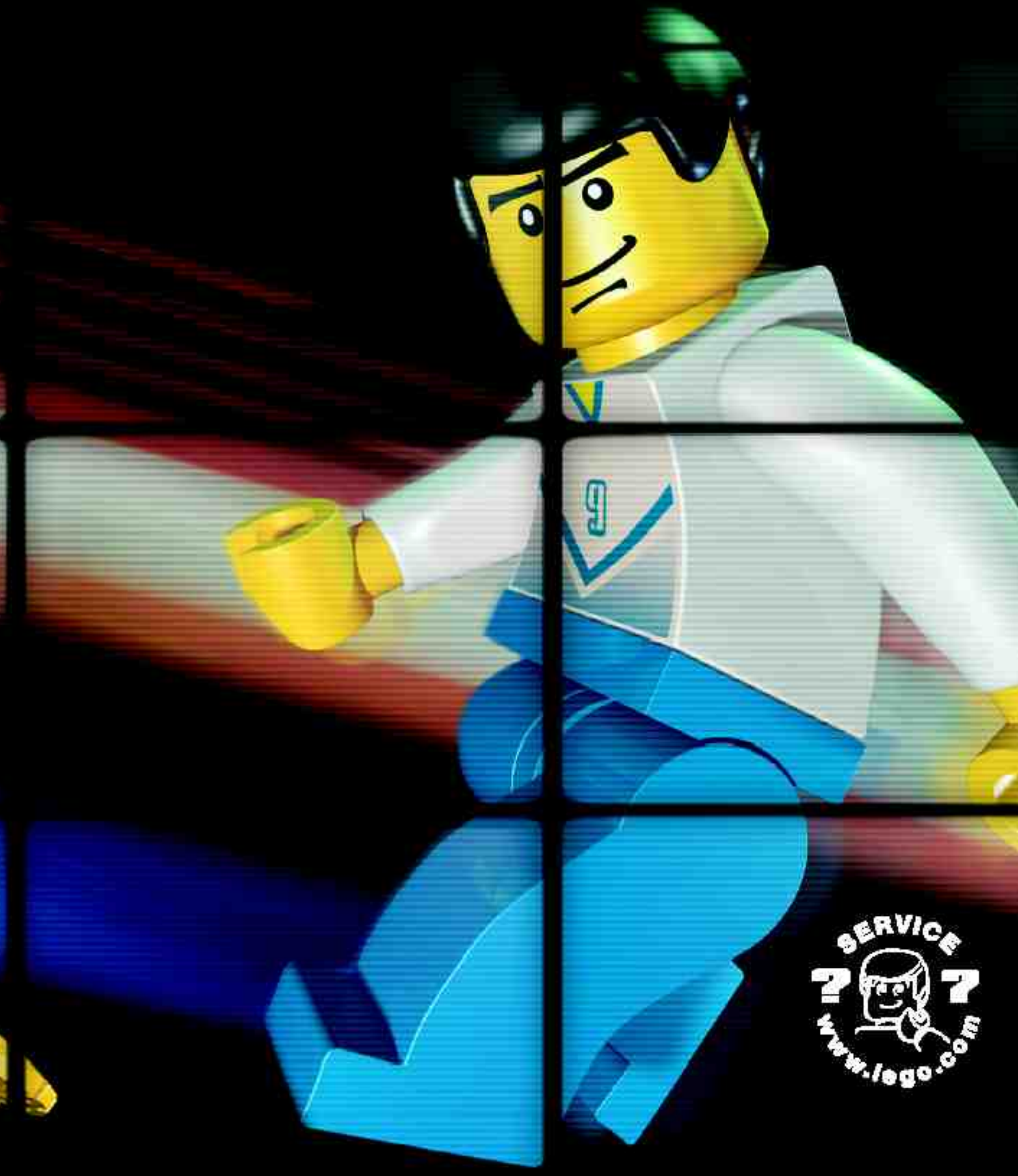

SPALDING is a trademark of Spalding Sports Worldwide, Inc. or Lisco Sports, Inc., a Spalding affiliate. © Spalding Sports Worldwide, Inc. 2002

adidas, the adidas logo and the three stripe trademark are registered trademarks of the adidas-Salomon group, used with permission. Fevernova and the Trigon logo are trademarks of the adidas-Salomon group, used with permission.

LEGO and the LEGO logo are trademarks of the LEGO Group. ©2002 The LEGO Group.

NBA identifications depicted are the exclusive property of NBA Properties, Inc. and/or the NBA Member Teams, and are used with permission.

 www.LEGO.com

